



- ✓ Work & Logging
- ✓ Pulling & Show
- ✓ Marathon
- ✓ Chuck Wagon
- ✓ Pleasure & Driving
- ✓ Collars & Hames
- ✓ Sweat Pads
- ✓ Tools & Hardware
- ✓ Equine & Leather Care
- ✓ Blankets and Grooming
- ✓ Much more...



The Canadian Distributor for Biothane USA!

Great product for harness, pet products, waist belts and much more. Call us today for your wholesale or retail needs!

Home / Products / Harnesses & Optional Parts / Draft Size Harness / Team Draft Harness / 410 Granite Team Harness Less Hames



Enlarge Photo

Product ID: 410-S

410 Granite Team Harness Less Hames

Traces	Granite Draft Spotted Flared Traces	View Images
Back Bands	<input type="text" value="-- None --"/> <input type="text" value="Granite Draft Spotted Flared Traces"/> <input type="text" value="Granite Traces W/Swivel Chain"/>	pages
Billets	<input type="text" value="410 Traces W/#80 Swivel/Clips"/> <input type="text" value="410 Ring Traces W/ Flares/#71/#80 Swivel SS"/>	pages
Belly Band	408/410 Belly Band W/SS	View Images
Breast Strap	1 1/2"Gran Draft Breaststrap W/523	View Images
Martingale	Granite Draft Martingale W/1616	View Images

Check out our new Online Store!

Now with customer logins, customer-based pricing, optional harness components and much more.



AARON MARTIN HARNESS LTD.

4445 Posey Line, Wallenstein, Ontario Canada N0B 2S0

Order Line: 1-800-367-0639

Web Site: www.aaronmartin.com

Telephone: (519) 698-2754 Toll Free Fax: 1-888-753-4525

E-mail: info@aaronmartin.com



AARON MARTIN HARNESS LTD. WATERLOO

(On Posey Line)

From 401 follow #8 to #85 to Line 86 thru Wallenstein, left onto Lavery Road, left again onto Posey Line, then third driveway on the left.

GPS USERS: Enter address as:
4445 Posey Line, Wellesley, ON

or

Latitude: 43.5902N

Longitude: 80.68174W

Please read the following copy carefully.

TO OUR CUSTOMERS:

We welcome you to our **new Catalogue**, which we have been trying to get together for quite some time. We hope you will find it straight-forward and practical for your use. We reserve the right to change any errors or misprints in numbers or prices. There are many

products shown in the catalogue, but if there is anything you don't see, feel free to ask (especially in the Draft Horse line). Please order far enough in advance to allow for processing and delivery of your order. Orders will be shipped as promptly as possible.

NOTE: We will not be liable or responsible for any type of accident that may arise from the use of our products. Use all our products at your own risk.



NEW! BUSINESS HOURS:

Open Monday to Friday 7:00 a.m. – 5:00 p.m.

Closed Saturday and Sunday

TERMS & CONDITIONS:

Payment by Credit Card, Money Order or PayPal, E- Transfer, & Bank Draft



NEW ACCOUNTS

DELIVERY

We try to ship the most economical way, usually by UPS, Loomis or Canada Post. (Larger shipments will be made by transport). Please specify if another method is preferred.

BACK ORDERS

These will be shipped as our stock becomes available. **NOTE: Any back orders over 2 months will be cancelled, except special orders. If cancelled orders are still required, please reorder.**

RETURN OR EXCHANGE

If for any reason you are not completely satisfied with any of our products that you have received, **please contact us** for an exchange or refund. Returning products for any other reason are subject to a 15% restocking charge with prior authorization from our staff.

NOTE: Tax will be charged for the appropriate province.

TEL: 1-800-367-0639

Your Satisfaction is our Satisfaction

FAX: 1-888-753-4525

COMPANY HISTORY

Aaron Martin Harness has been manufacturing harnesses for horses and pets, plus any custom made products in other fields, in our facility near Wallenstein, Ontario, Canada since 1980. What started out as a small business venture has grown into a business that serves the Draft and Driving horse industry worldwide. With a number of years of experience in this trade prior to 1980 and having worked with draft and driving horses all our lives, harness and horses came as nothing new to us. Customers. Since we manufacture our harnesses right on site we are able to provide the best customer service possible. If there is any problem with a size or style of a harness, collar, harness, pads, etc., or if you need a harness made to your specifications, be it a special size or design, we are able to address these issues immediately, right within our shop. Although we started as a Retail Outlet (Mail Order) with customers right across Canada, we now serve customers in the USA, England, Germany, Scotland, Switzerland, Australia and many other overseas destinations with harnesses and other supplies. By request we now successfully sell our products in many tack shops, feed mills and stores. Our facility, which started out in a small shop. If you are ever in the area, please feel free to stop in and check us out!

NOTICE TO OUR CUSTOMERS

USED HARNESSSES:

Periodically we have good used harnesses, collars and pads for sale. If interested give us a call to see what we have at that time, or check us out on our website (Used & Clearouts). We also buy or trade-in used harnesses depending on the kind and condition. Another option we have is to sell your used harness on a consignment basis where we charge only a small fee for handling.

SPECIALS OR CLEAROUTS

Now and then we make halters, shanks, harness parts, etc. from clearout materials at very low prices. So, when you write or call, ask about our specials, clearouts or seconds.

CUSTOM CHROME PLATING

We have chrome plating done on a regular basis. Send or bring your parts in for a quote to chrome plate. Brass plating is also available. (Allow 2 to 4 weeks.)

HARNESS SERVICED

Harnesses may be brought or shipped in for repairs, cleaning or oiling. Cost estimates available at that time if required.

Information en langue Française

Nous offrons maintenant le service à la clientèle en français. Ils peuvent répondre à vos questions concernant nos produits et vous aider à placer vos commandes. Vous pouvez communiquer directement avec eux ou nous pouvons vous transférer.

Nom : Linda ou Germain

Téléphone: 819-680-1470

Courriel: fermedesberges@gmail.com



MARTIN

SINCE/EST 1980

Equine & Pet Products

TABLE OF CONTENTS

HARNESSES & ACCESSORIES 4 - 31

COLLARS, SWEAT PADS, HAMES 32 - 38

SHOW SUPPLIES 39 - 40

HALTERS & LEADS 41 - 47
PETS & DAIRY SUPPLIES

HORSE CARE 48 - 58

STABLE SUPPLIES 59 - 66

BELLS, GIFTS, CALENDARS, BOOKS 67 - 78

HARNESSES MAKER SUPPLIES 79 - 107

HARDWARE 108 - 123

EQUIPMENT 124 - 128

Reference charts showing names and locations of harness parts.
(Numbers in brackets are our part number)

DRAFT STYLE HARNESS

NAMES OF HARNESS PARTS

(Applies to Team Harness Only)

- #1 Brow Band (44)
- #1W Winker (41)
- #2 Blind
- #3 Nose Band
- #4 Bit Straps (42)
- #5 Bit
- #6 Gag Swivel
- #7 Rein Front
- #8 Throat Latch (40)
- #9 Side Check (43)
- #10 Head Stall or Bridle Top (39)
- #11 Hame Ball (75)
- #12 Hame
- #13 Lines or Reins (24)
- #14 Back Bands (12)
- #16 Flare
- #17 Billet (14)
- #18 Belly Band (16)
- #19 Hold Back (34)
- #20 No. 919 Connector
- #21 Hame Strap (22)
- #22 Breast Strap (18)
- #23 No. 1616 Snap
- #24 Martingale (20)

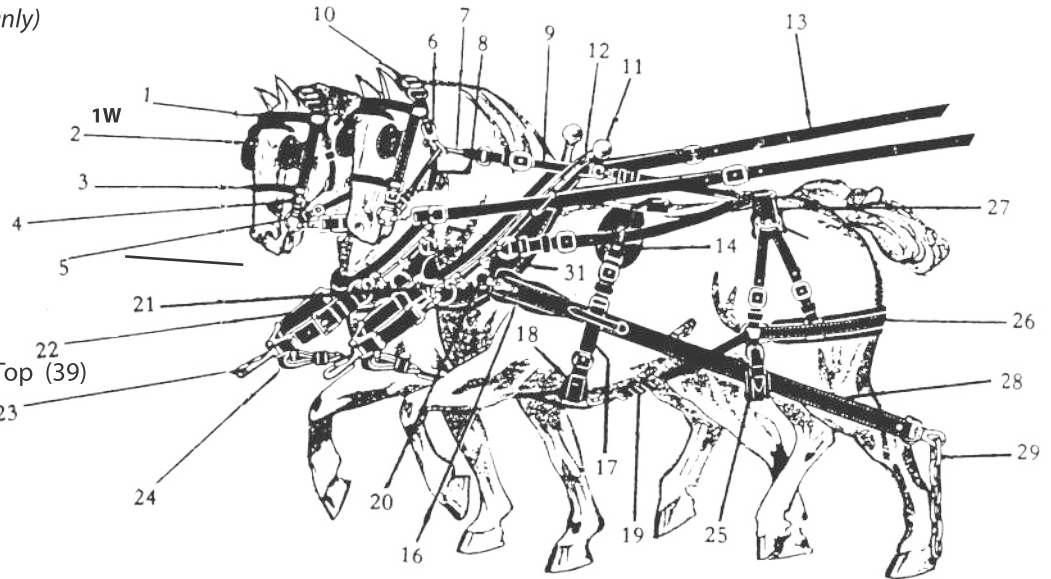

- #25 Lazy Strap or Trace Carrier (32)
- #26 Breeching Seat (30)
- #27 Breeching Top (28)
- #28 Trace (10)
- #29 Heel Chain (66)

ROAD STYLE HARNESS

NAMES OF HARNESS PARTS

(Applies to Single Buggy Harness Only)

- #1 Brow Band (44)
- #1W Winker (41)
- #2 Blind
- #3 Overcheck (front)
- #4 Cheek
- #5 Bit (46)
- #6 Head Stall or Bridle Top (39)
- #7 Throat Latch (40)
- #8 Overcheck (62)
- #9 Check Hook (9)
- #10 Terret (5)
- #11 Lines (front) (24)
- #12 Lines (hand parts)
- #13 Crooper (17)
- #14 Breeching Seat (30)
- #15 Hold Back (34)
- #16 Traces (10)
- #17 Saddle or Back Band (12)
- #19 Shaft Loop (15)
- #20 Breast Collar (10)

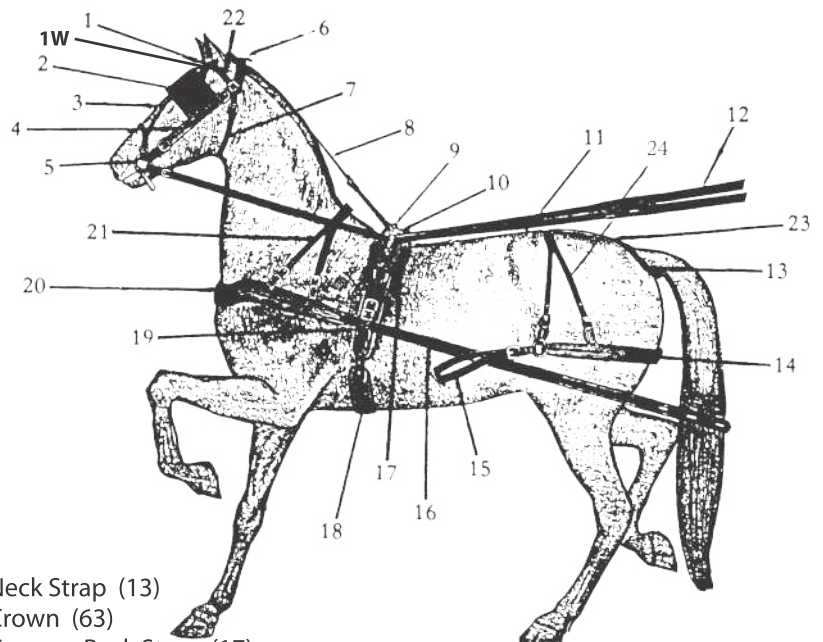

- #21 Neck Strap (13)
- #22 Crown (63)
- #23 Crooper Back Strap (17)
- #24 Hip Strap (single) (19)

HORSE/HARNESS MEASUREMENT GUIDE (Imperial)

See next page
for Metric Units

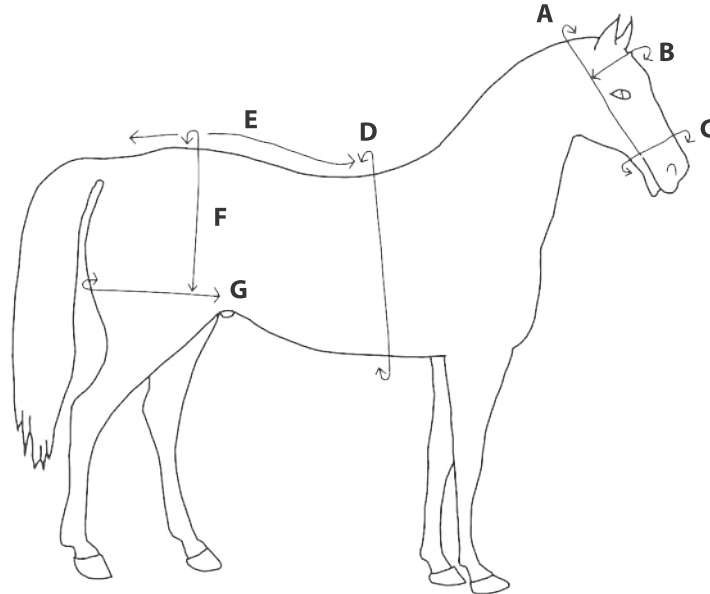

The measurements below are from smallest to largest settings for our standard harnesses.

MINIATURE SINGLE SIZE

#110M, #116, #118, #418

- A: 23" to 32" from corner of mouth to corner of mouth
- B: 13" brow band
- C: 10" nose band
- D: 43" to 50" girth (right around body)
- E: 23" to 31" from back band to dock
- F: 21" to 29" over loin
- G: 28" from flank to flank

MINI TEAM SIZE

#287, #426, #445, #487, #816, #925, #930, #935, #945

- A: 23" to 32" from corner of mouth to corner of mouth
- B: 13" brow band
- C: 10" nose band
- D: 43" to 51" girth (right around body)
- E: 30" to 35" from back band to dock
- F: 31" to 35" over loin
- G: 28" from flank to flank

PONY SINGLE SIZE

#110P, #113, #317, #413

- A: 28" to 36" from corner of mouth to corner of mouth
- B: 15" brow band
- C: 11" nose band
- D: 52" to 62" girth (right around body)
- E: 29" to 39" from back band to dock
- F: 26" to 38" over loin
- G: 36" from flank to flank

PONY TEAM SIZE

#289, #292, #452, #453, #469, #552, #572, #582, #819

- A: 33" to 40" from corner of mouth to corner of mouth
- B: 15" brow band
- C: 11" nose band
- D: 53" to 67" girth (right around body)
- E: 30" to 40" from back band to dock
- F: 38" to 45" over loin
- G: 37" from flank to flank

COB SINGLE SIZE

#110C, #114, #415, #717

- A: 32" to 40" from corner of mouth to corner of mouth
- B: 15" brow band
- C: 13" nose band
- D: 54" to 66" girth (right around body)
- E: 34" to 40" from back band to dock
- F: 40" to 48" over loin
- G: 42" from flank to flank

HORSE SIZE

#110H, #115, #117, #120, #250, #270, #284, #285, #380, #417, #485

- A: 35" to 47" from corner of mouth to corner of mouth
- B: 17" brow band
- C: 15" nose band
- D: 66" to 74" girth (right around body)
- E: 40" to 48" from back band to dock
- F: 45" to 54" over loin
- G: 48" from flank to flank

HALFLINGER SIZE

#213, #284, #294, #380, #409, #450, #482, #540, #550, #575, #580, #680

- A: 42" to 50" from corner of mouth to corner of mouth
- B: 17" brow band
- C: 14 1/2" nose band
- D: 68" to 85" girth (right around body)
- E: 32" to 42" from back band to dock
- F: 53" to 63" over loin
- G: 44" from flank to flank

DRAFT SIZE

#208, #210, #211, #215, #230, #235, #295, #408, #410, #435, #710

- A: 48" to 54" from corner of mouth to corner of mouth
- B: 19" brow band
- C: 16" nose band
- D: 79" to 90" girth (right around body)
- E: 35" to 44" from back band to dock
- F: 60" to 65" over loin
- G: 51" from flank to flank

PULLING HARNESS

#280, #282, #480

- A: 52" to 58" from corner of mouth to corner of mouth
- B: 19" brow band
- C: 16" nose band
- D: 84" to 104" girth (right around body)
- E: 35" to 44" from back band to dock
- F: 65" to 73" over loin
- G: 60" from flank to flank

HORSE/HARNESS MEASUREMENT GUIDE (metric)

See previous page
for Imperial Units

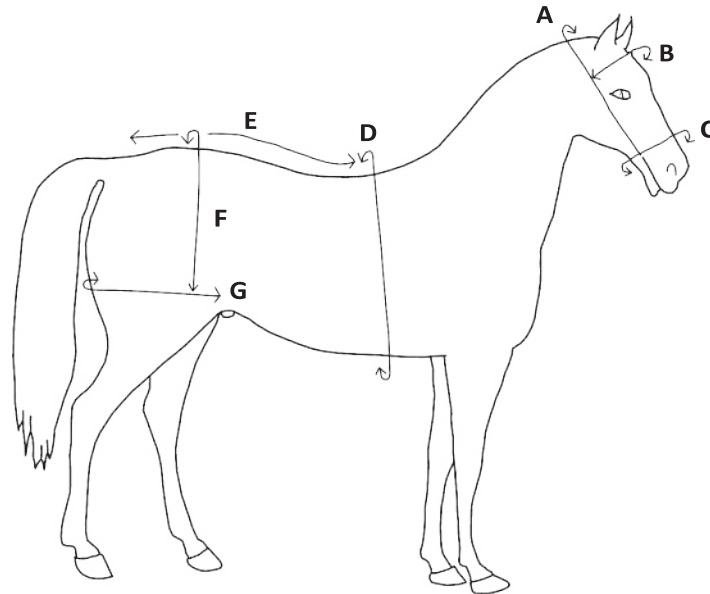

The measurements below are from smallest to largest settings for our standard harnesses.

MINIATURESINGLE SIZE

#110M #116, #118, #418

- A: 58cm to 81cm from corner of mouth to corner of mouth
- B: 33cm brow band
- C: 25cm nose band
- D: 109cm to 127cm girth (right around body)
- E: 58cm to 79cm from back band to dock
- F: 53cm to 74cm overloin
- G: 71cm from flank to flank

MINI TEAM SIZE

#287, #426, #445, #487, #816, #925, #930, #935, #945

- A: 58cm to 81cm from corner of mouth to corner of mouth
- B: 33cm brow band
- C: 25cm nose band
- D: 109cm - 130cm girth (right around body)
- E: 76cm to 89cm from back band to dock
- F: 79cm to 89cm over loin
- G: 71cm from flank to flank

PONY SINGLE SIZE

#110P, #113, #317, #413

- A: 71cm to 91cm from corner of mouth to corner of mouth
- B: 38cm brow band
- C: 28cm nose band
- D: 132cm to 157cm girth (right around body)
- E: 74cm to 99cm from back band to dock
- F: 66cm to 97cm overloin
- G: 91cm from flank to flank

PONY TEAM SIZE

#289, #292, #452, #453, #469, #552, #572, #582, #819

- A: 84cm to 102cm from corner of mouth to corner of mouth
- B: 38cm brow band
- C: 28cm nose band
- D: 135cm - 170cm girth (right around body)
- E: 76cm to 102cm from back band to dock
- F: 97cm to 114cm over loin
- G: 94cm from flank to flank

COB SINGLE SIZE #110C, #114, #415, #717

- A: 81cm to 102cm from corner of mouth to corner of mouth
- B: 38cm brow band
- C: 33cm nose band
- D: 137cm - 168cm girth (right around body)
- E: 86cm to 102cm from back band to dock
- F: 102cm to 122cm overloin
- G: 107cm from flank to flank

HORSE SIZE

#110H, #115, #117, #120, #250, #270, #284, #285, #380, #417, #485

- A: 89cm to 119cm from corner of mouth to corner of mouth
- B: 43cm brow band
- C: 38cm nose band
- D: 168cm - 188cm girth (right around body)
- E: 102cm to 122cm from back band to dock
- F: 114cm to 137cm overloin
- G: 122cm from flank to flank

HALFLINGER SIZE

#213, #284, #294, #380, #409, #450, #482, #540, #550, #575, #580, #680

- A: 107cm to 127cm from corner of mouth to corner of mouth
- B: 43cm brow band
- C: 37cm nose band
- D: 173cm - 216cm girth (right around body)
- E: 81cm to 107cm from back band to dock
- F: 135cm to 160cm overloin
- G: 112cm from flank to flank

DRAFT SIZE

#208, #210, #211, #215, #230, #235, #295, #408, #410, #435, #710,

- A: 122cm to 137cm from corner of mouth to corner of mouth
- B: 48cm brow band
- C: 41cm nose band
- D: 201cm-229cm girth (right around body)
- E: 89cm to 112cm from back band to dock
- F: 152cm to 165cm overloin
- G: 130cm from flank to flank

PULLING HARNESS #280, #282, #480

- A: 132cm to 147cm from corner of mouth to corner of mouth
- B: 48cm brow band
- C: 41cm nose band
- D: 213cm-264cm girth (right around body)
- E: 89cm to 112cm from back band to dock
- F: 165cm to 185cm over loin
- G: 152cm from flank to flank

SPECIAL ORDER HARNESS MEASUREMENT FORM

Date _____

Customer _____

Phone No. _____ Fax No. _____

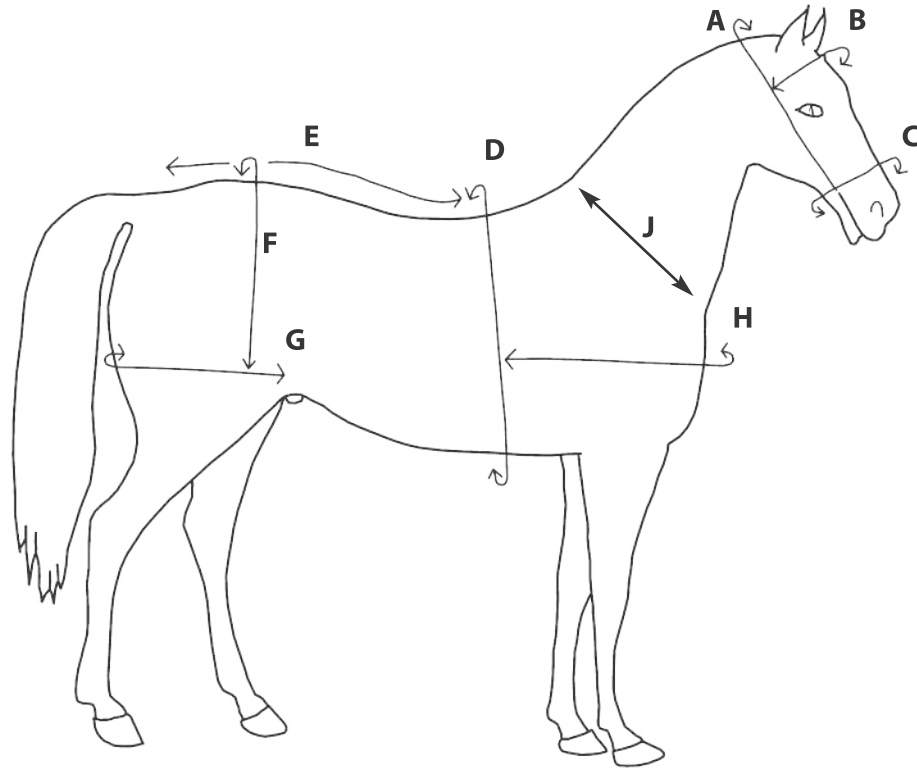

Breed of horse _____

Height of horse _____ Hands

Weight of horse _____ lbs or kg

Type of harness _____

A. From corner of mouth to corner of mouth _____

B. Brow band _____

C. Nose band _____

D. Girth (Right around body) _____

E. From back band to dock _____

F. Over loin _____

G. From flank to flank _____

H. From shoulder to shoulder _____

J. Collar Size _____

HARNESS ASSEMBLY TIPS

Experience Tells Us...

- Horses prefer to be harnessed from their left side
- For your safety, keep your horse tied while harnessing

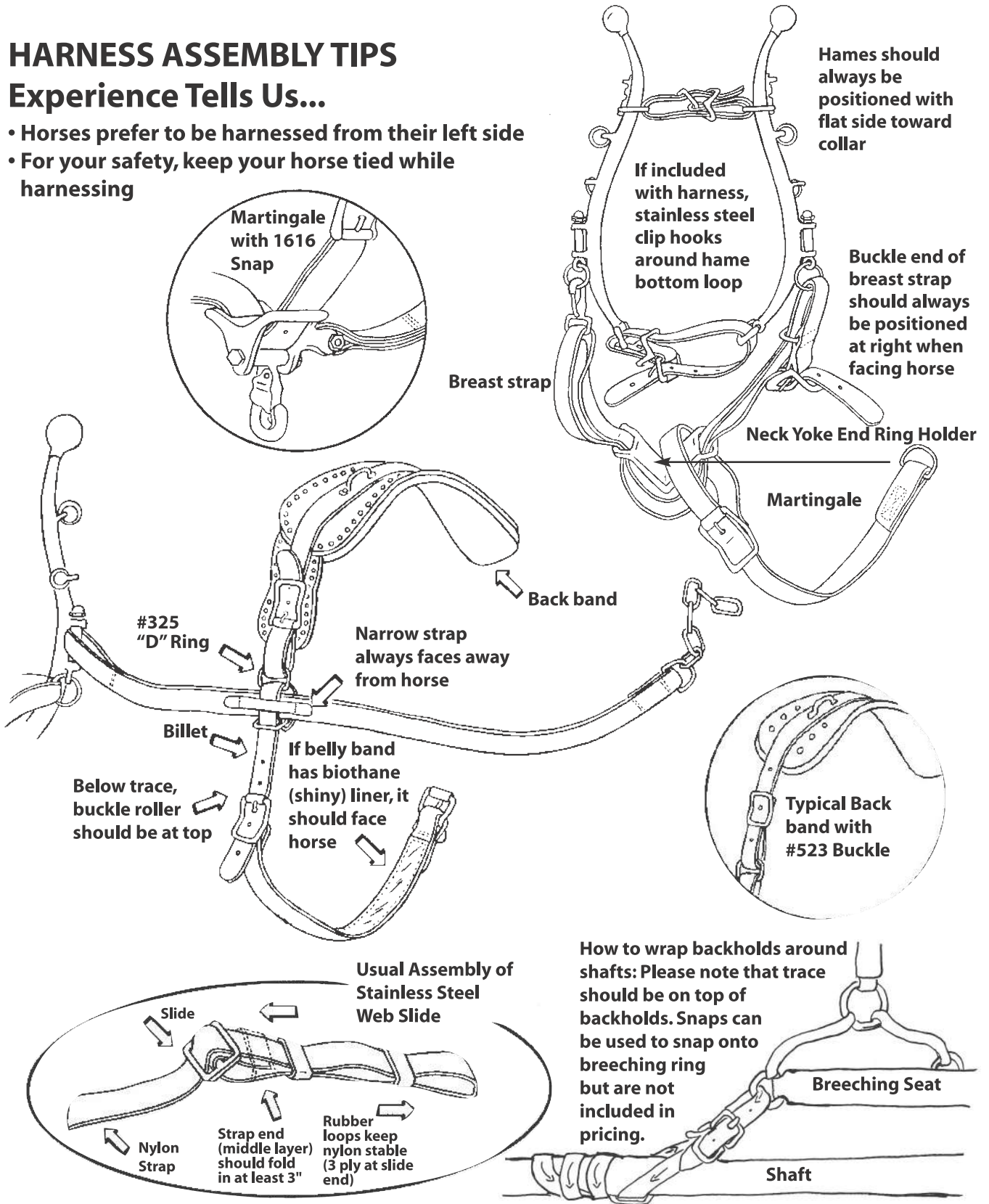



Photo: Josh Michaud, St. Paul, AB
With his #409 Granite Harness.



Photo: Katie Ward, Ibstock, Leicestershire,
United Kingdom, Logging with her #408 harness.



Photo: Garr Nebras, Langenburg, SK
Out for a sleigh ride with his #450 Harness.



Photo: Russ Hollett, Little Britain, ON
Special order pulling harness.



Photo: Brian Jensen, Lumby, BC
Driving a Quadrom of 4 in line of Fjord's all with
harness from Aaron Martin Harness Ltd.



Photo: Red Roof Retreat, Niagara On The Lake, ON
With harness and Pioneer 1 ton Trailway wagon.

We are looking for good quality photos to use in future catalogues & publications. Please send to info@aaronmartin.com

A BRIEF HARNESS INTRODUCTORY

If you are a first time harness buyer and need assistance, our staff will gladly help you!

Welcome to our new catalogue, featuring new styles and many new sizes of harnesses. Most of these we keep in stock for immediate shipment. If you would like a size or style not shown, please ask for a price quote as we will try to build a harness to your liking! We also make specialty harnesses for many applications, from goats to dogs. We also manufacture many products not related to the harness industry, so if needing a certain item made that is not available or too costly elsewhere give us a try.

Under each style of harness the sizes are listed, each size will be built in proportion. Please Note: If a harness does not fit properly we will modify or exchange it. All standard parts are listed under each harness but feel free to exchange a standard part for an optional part on the page beside.

If wanting a single draft style harness see page 27 for a single setup. Choose a model you want and add an (S) (examples #210S / #580S / #572S) When ordering parts only, choose the model plus the part number. (Example -#208-18 breaststrap / #115-34 hold backs / #418-38 bridle) check if priced per set , pair , or each.

All of our harnesses are made within the community so we have a tight quality control. If there is a problem with workmanship or quality please let us know. We try to use the most durable materials we can find to build our harnesses, and are always striving to improve our products. Listed below is a brief description of materials we use:

Biothane, Granite, Beta are bought from a long established company – Bioplastics

Biothane – a nylon webbing, coated with a hard shiny urethane, the most durable material used for harnesses.

Granite – a nylon webbing, coated with a dull black PVC, leather look, very durable, more flexible than biothane, the most popular material for harnesses as it resembles leather but much stronger, very lightweight, and easy to maintain.

Beta – a nylon webbing coated with soft PVC, most popular for lines, very strong and flexible, all our synthetic harnesses come with these lines.

Nylon – the most durable and strongest material used to build harnesses etc., also the most inexpensive!

Please Note – The 4 materials above can be washed with soap and water or use pressure washer without harm to harnesses!

Leather- we make all our styles and models in genuine leather on special order, as it is the most expensive material although the most durable, it will last a lifetime if taken care of properly!

All special orders require a 50% down-payment at time of order, balance upon delivery. See page 6 for special harness measurement form. Fill out and email, fax or mail it upon ordering.

Harness Service: Any type of harness can be brought or shipped in for cleaning, oiling, repairs or alterations.

SAFETY HINTS !

Never

- Try to put a bridle on a horse when away from home without first securing him with a rope around his neck.
- Start to hitch a horse to a vehicle without having the line (reins) fastened onto bit.
- Try to back a horse between shafts that are lying on the ground.
- Leave the lines unbuckled in case one should be dropped while driving or getting on or off vehicle.
- Take off bridle while horse is hitched to vehicle, even when he has a halter on or when tied up.
- Leave a nervous horse tied to the side of trailer or van.
- Start to unhitch a horse in unfamiliar surroundings without a capable person helping.
- Allow a person to sit in the carriage before the driver has taken his place.
- Drive too close to the carriage in front of you.
- Allow your attention to be distracted.
- Take a completely green horse to a show or driving event, first find out how he behaves when being driven at home.
- Allow horses to canter or gallop in harness - Only the most skilled drivers should do so.

Always

- Remember to signal to other traffic before turning.
- Take great care in passing another carriage, make sure you have a clear view of road in front.
- Have an active and capable person with you when driving a green broke horse.
- Be watchful of your horse , especially his ears, which may give warning of his alarm at something he has seen or heard.

ABBREVIATIONS THROUGHOUT THIS CATALOGUE

CHR – Chrome Plated

Plain – Zinc, Black or Bare

NP – Nickel Plated

PVC – Poly Vinyl Coated

SS – Stainless Steel

BP – Brass Plated

Draft – Size 1700 - 2200 lbs.

ZDC - Zinc Die Cast

BR – Solid Brass

Horse – Size 800 - 1200 lbs.

BK – Black

PULLING OR PARADE HARNESS

MADE WITH POLISHED SS SPOTS

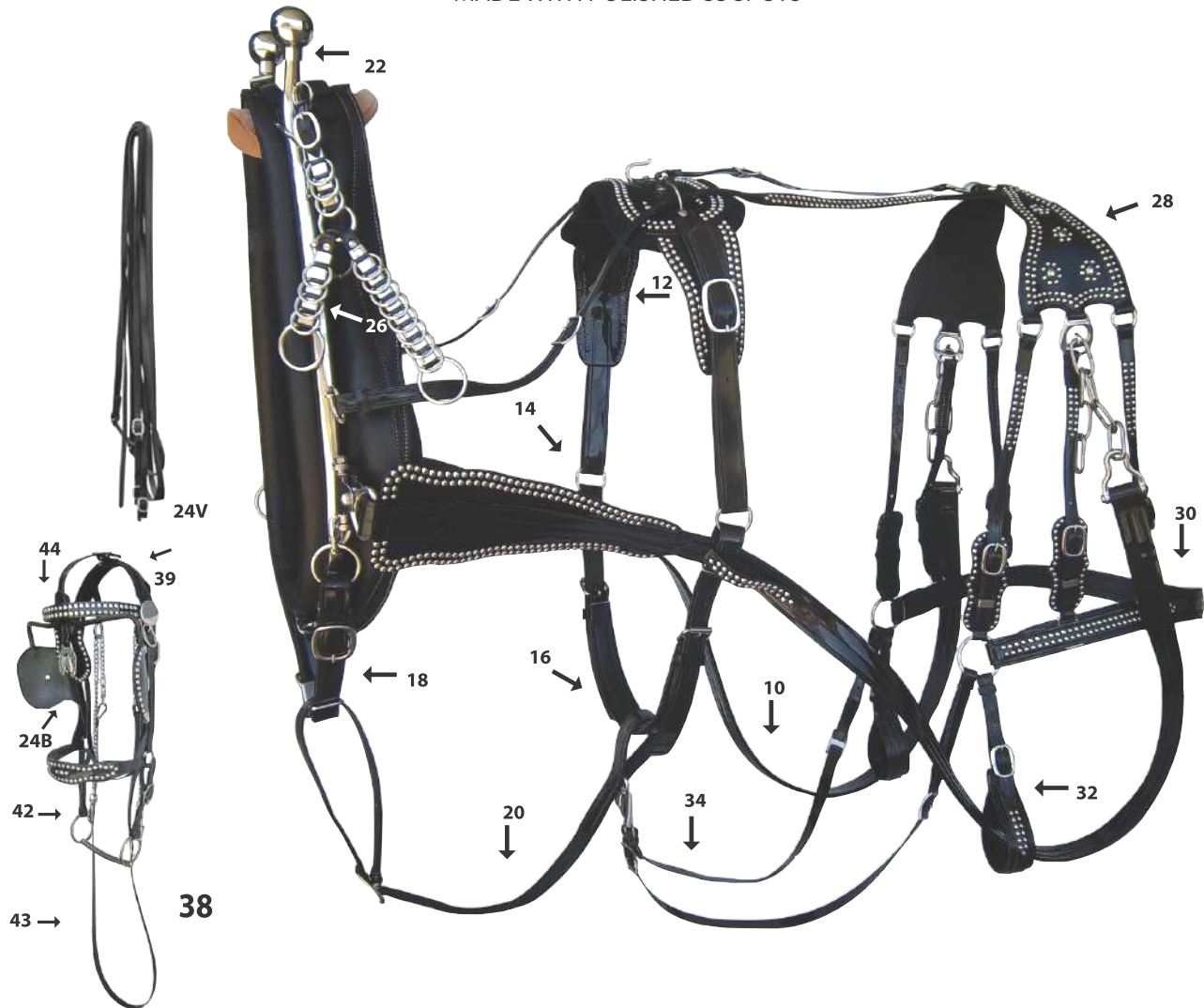

PULLING OR PARADE HARNESS

This harness is a super deluxe model with well over 3000 polished stainless steel spots on the draft set and has more body than the regular harnesses. So this is a good choice for pulling or parades. Has 3 strap breeching and double ring spreads. Your choice of #705 or #700 hames. Has rolled belly band and breeching.

STANDARD PARTS

- #700 Hames All Chrome
- #10 Traces
- #12 Back Bands
- #14 Billets
- #16 Belly Bands
- #18 Breast Straps
- #20 Martingales
- #97 Hame Strap
- #98 Hame Strap
- #24 Lines
- #26 Spreads

- #28 Breeching Tops
 - #30 Breeching Seats
 - #32 Trace Carriers
 - #34 Hold Backs
 - #38 Bridle
 - #39 Crown
 - #40 Throat Latch
 - #42 Bit Straps
 - #44 Brow Band
 - #73 Back Band to Breeching Strap
 - #24B Spotted Face Drop
- Collars are not included in price.**

LEATHER		
MODEL #	SIZE	HAME#
282	Draft 1600-2200lb	705/700
284	Horse 800-1300lb	705P
GRANITE		
480	Draft 1600-2200lb	705/700
481	Horse 800-1300lb	705P
BIOTHANE		
280	Draft 1600-2200lb	705/700
380	Horse 800-1300lb	705P

OPTIONAL PARTS

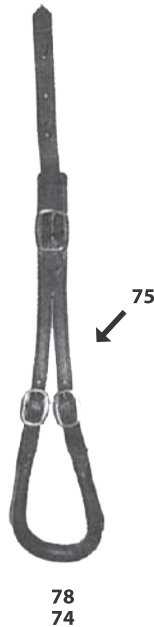
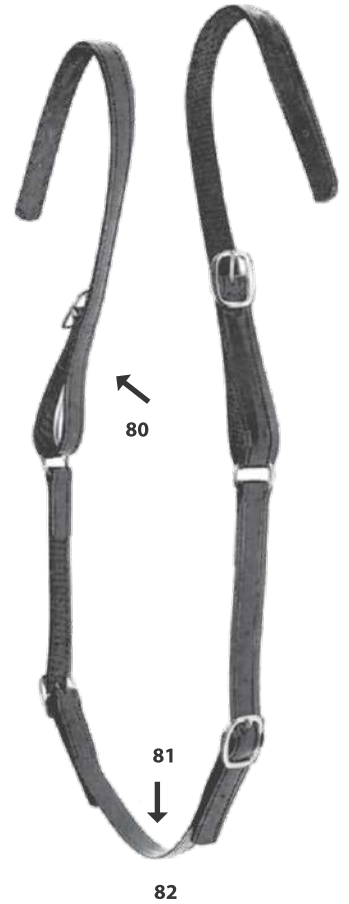

OPTIONAL PARTS

- #105 Traces with Swivel Dee
- #22 1" x 25" Hame Strap
- #50 Back Band with Dees
- #52 Back Band with Hook & Terrets
- #74 Crooper to Breeching Ring
- #75 Crooper Strap only
- #78 Docks with #520 buckles
- #80 Single Hitch Shaft Loop
- #81 Single Hitch Belly Band
- #82 Single Hitch Complete
- #84 #1616 Martingale
- #87 Single Lines
- #90 Long Billet
- #95 1" x 30" Hame Strap
- #96 1" x 36" Hame Strap
- #97 1 1/4" x 25" Hame Strap
- #98 1 1/4" x 30" Hame Strap
- #99 1 1/4" x 36" Hame Strap

PARADE TEAM HARNESS

MADE WITH POLISHED SS SPOTS

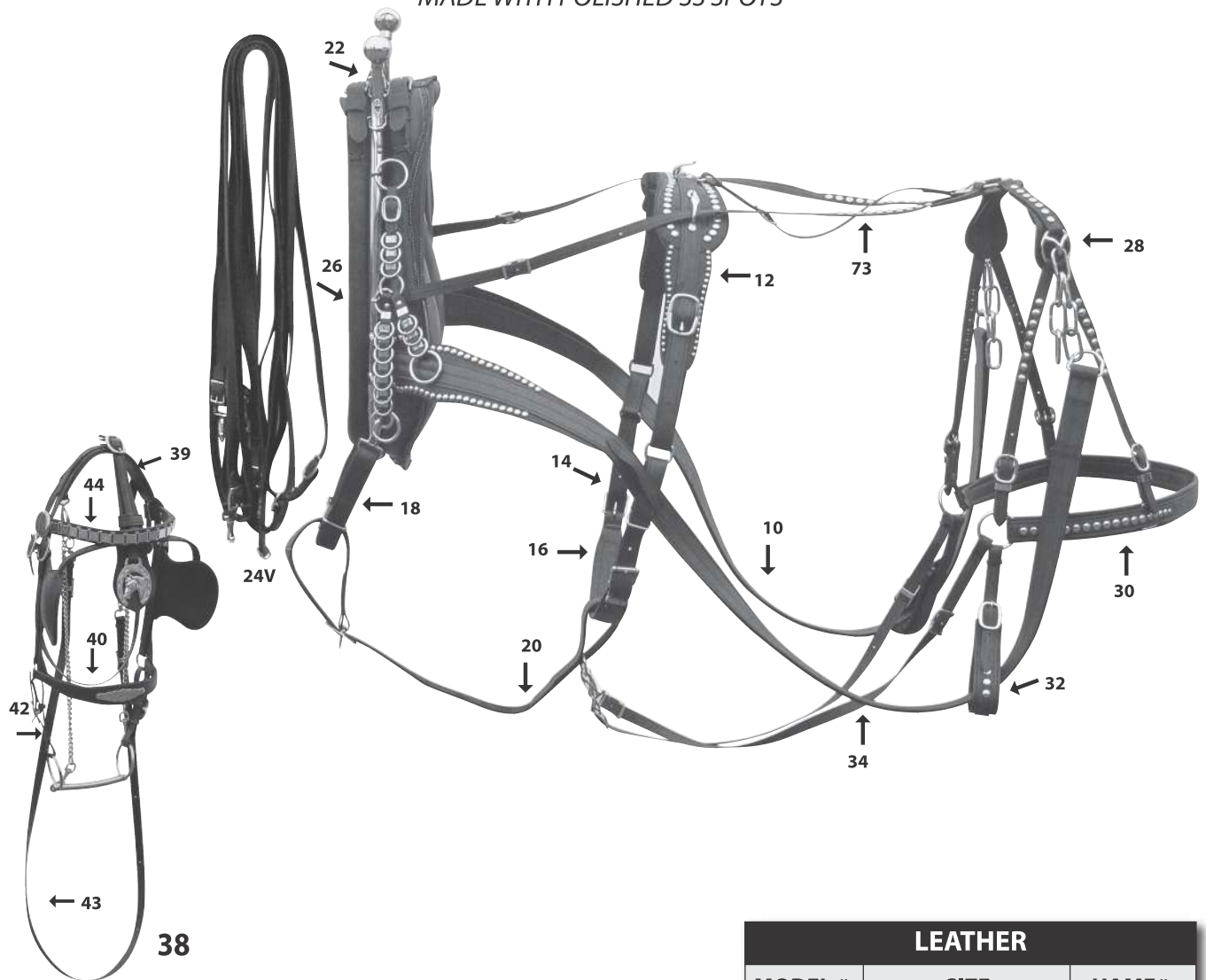

PARADE TEAM HARNESS

This harness is a good choice for doing parades, weddings and hayrides, etc. Made with all stainless steel hardware and has lots of spots. Has rolled belly band and breeching. Comes with a set of #705 black chrome hames and double ring spreads.

STANDARD PARTS

- #705 Hames Black Chrome
- #10 Traces
- #12 Back Bands
- #14 Billets
- #16 Belly Bands
- #18 Breast Straps
- #20 Martingales
- #22 Hames Straps
- #23 Hame Strap w/Clip
- #24 Lines
- #26 Spreads

- #28 Breeching Tops
 - #30 Breeching Seats
 - #32 Trace Carriers
 - #34 Hold Backs
 - #38 Bridle
 - #40 Throat Latch
 - #42 Bit Straps
 - #43 Side Check
 - #44 Brow Band
 - #73 Back Band to Breeching Strap
- Collars are not included in price.**

LEATHER		
MODEL #	SIZE	HAME#
230	Draft 1600-2200lb	705
540	Horse 800-1300lb	705P
930	Miniature	705M
GRANITE		
435	Draft 1600-2200lb	705
450	Horse 800-1300lb	705P
452	Pony	705P
426	Miniature	705M
BIOTHANE		
235	Draft 1600-2200lb	705
550	Horse 800-1300lb	705P
552	Pony	705P
925	Miniature	705M

OPTIONAL PARTS

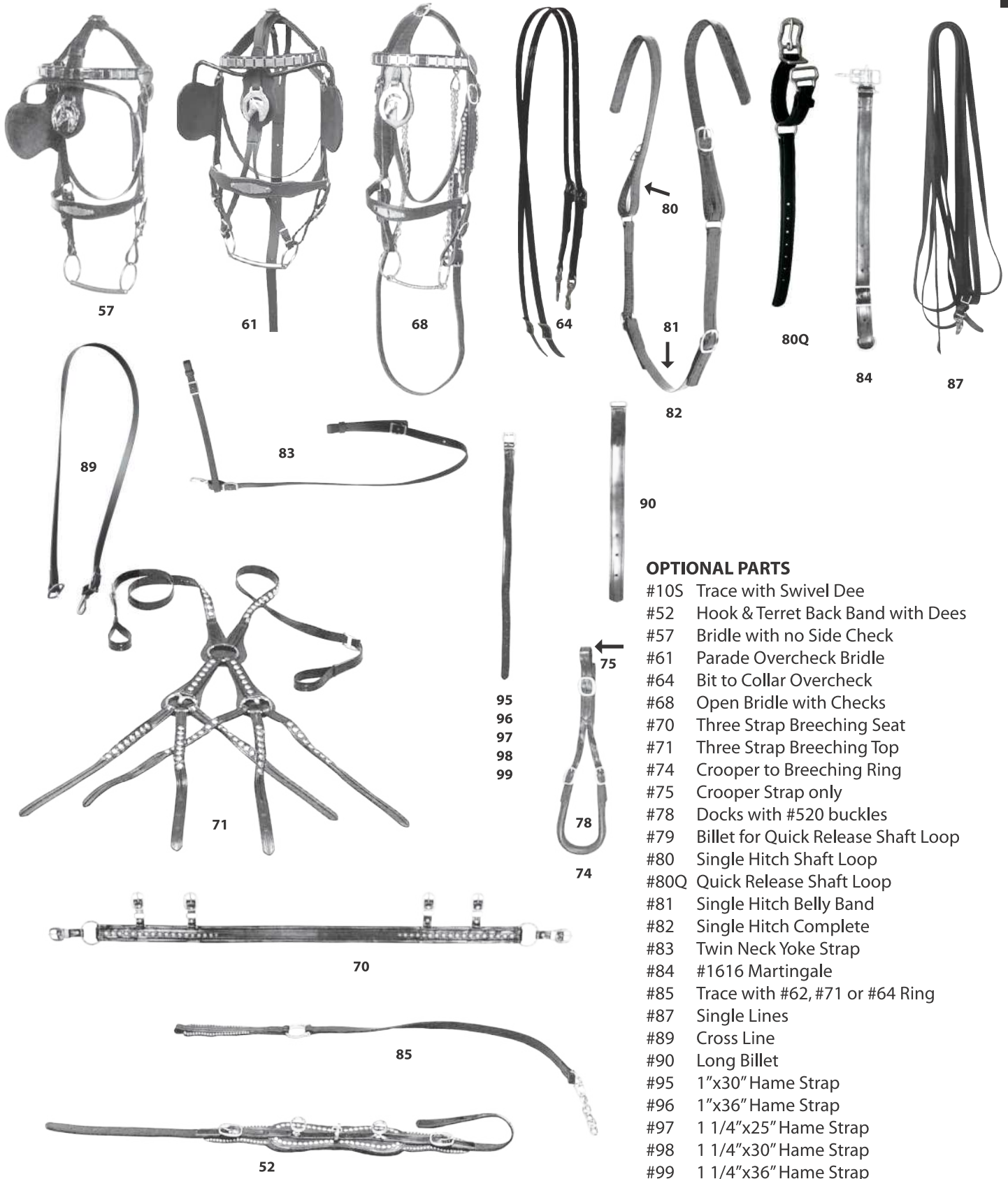

OPTIONAL PARTS

- #10S Trace with Swivel Dee
- #52 Hook & Terret Back Band with Dees
- #57 Bridle with no Side Check
- #61 Parade Overcheck Bridle
- #64 Bit to Collar Overcheck
- #68 Open Bridle with Checks
- #70 Three Strap Breeching Seat
- #71 Three Strap Breeching Top
- #74 Crooper to Breeching Ring
- #75 Crooper Strap only
- #78 Docks with #520 buckles
- #79 Billet for Quick Release Shaft Loop
- #80 Single Hitch Shaft Loop
- #80Q Quick Release Shaft Loop
- #81 Single Hitch Belly Band
- #82 Single Hitch Complete
- #83 Twin Neck Yoke Strap
- #84 #1616 Martingale
- #85 Trace with #62, #71 or #64 Ring
- #87 Single Lines
- #89 Cross Line
- #90 Long Billet
- #95 1"x30" Hame Strap
- #96 1"x36" Hame Strap
- #97 1 1/4"x25" Hame Strap
- #98 1 1/4"x30" Hame Strap
- #99 1 1/4"x36" Hame Strap

TEAM LEATHER WORK HARNESS

(Basic work harness)

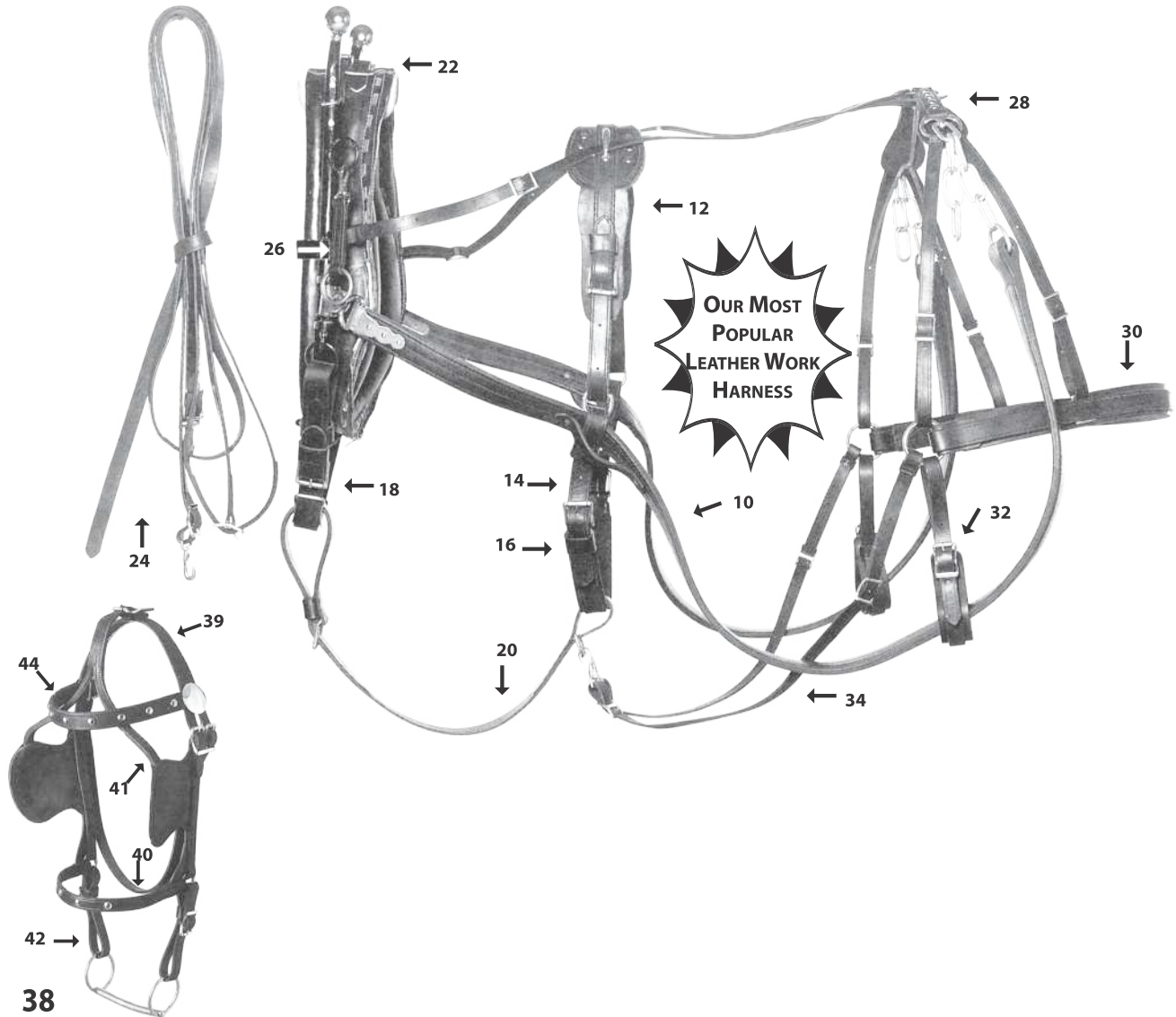

TEAM LEATHER WORK HARNESS

This harness is our most popular leather harness. A good choice for work but will also work for parades, etc. It is made from top quality harness leather, all stainless steel hardware and comes with a set of #705 black chrome hames.

STANDARD PARTS

- #705 Hames Black Chrome
- #10 Traces
- #12 Back Bands
- #14 Billets
- #16 Belly Bands
- #18 Breast Straps
- #20 Martingales
- #22 Hame Straps
- #24 Lines
- #26 Spreads
- #28 Breeching Tops
- #30 Breeching Seats
- #32 Trace Carriers
- #34 Hold Backs
- #38 Bridle
- #39 Crown
- #40 Throat Latch
- #41 Blind Stays
- #42 Bit Straps
- #44 Brow Band

Collars are not included in price.

LEATHER		
MODEL #	SIZE	HAME#
295	Draft 1600-2200lb	705
294	Horse 800-1300lb	705P
292	Pony	705P

OPTIONAL PARTS

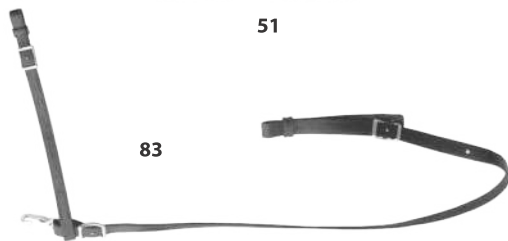
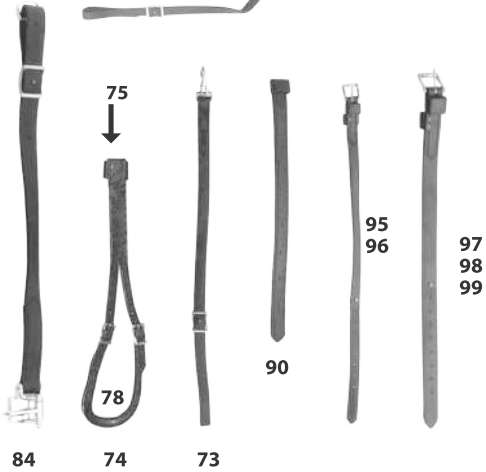
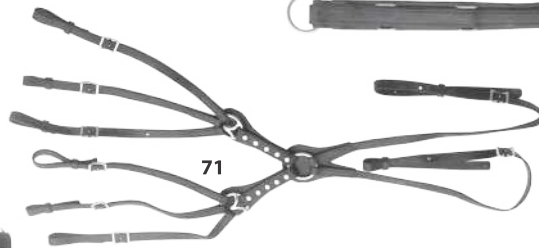
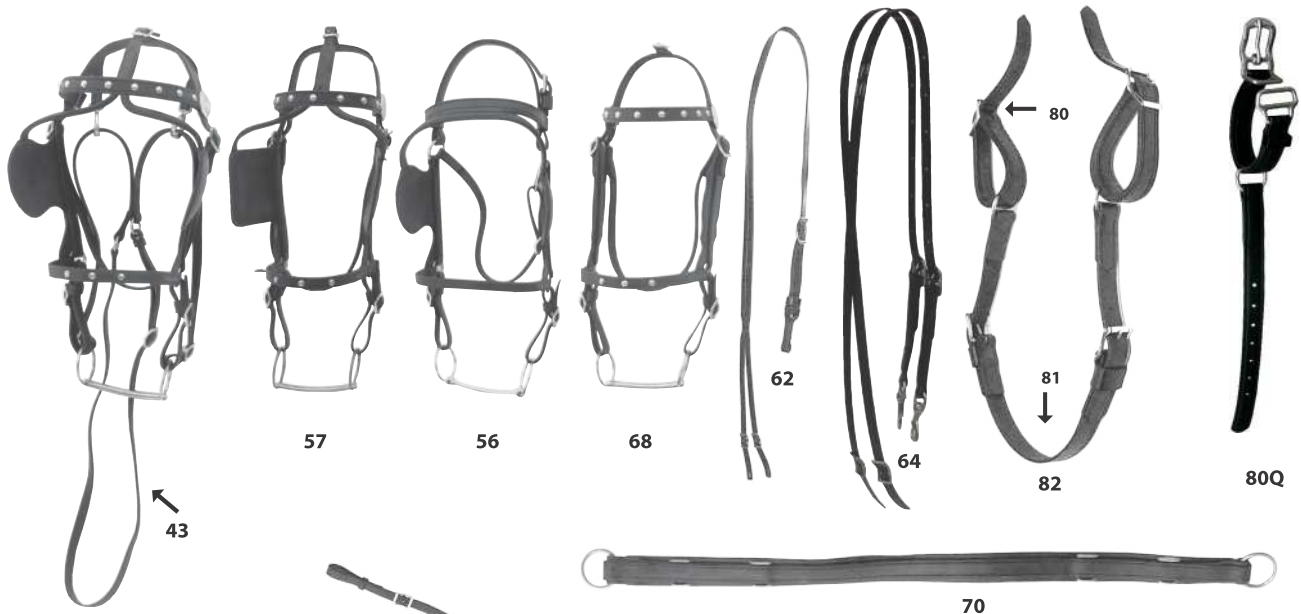

OPTIONAL PARTS

- #10S Trace with Swivel Dee
- #43 Side Check only
- #51 Back Band with Hook & Terret
- #56 Ring Crown Bridle
- #57 Square Blind Bridle
- #58 Side Check Bridle
- #62 Overcheck only
- #64 Bit to Collar Overcheck
- #68 Open Bridle
- #70 Three Strap Breeching Seat
- #71 Three Strap Breeching Top
- #73 Back Band to Breeching Strap
- #74 Crooper to Breeching Ring
- #75 Crooper Strap only
- #78 Dock with #523 Buckles
- #79 Billet for Quick Release Shaft Loop
- #80 Single Hitch Shaft Loop
- #80Q Quick Release Shaft Loop
- #81 Single Hitch Belly Band
- #82 Single Hitch Complete
- #83 Twin Neck Yoke Strap
- #84 #1616 Martingale
- #85 Traces with #62, #71 or #64 Ring
- #87 Single Lines
- #89 Cross Line
- #90 Long Billet
- #95 1"x30" Hame Strap
- #96 1"x36" Hame Strap
- #97 1 1/4"x25" Hame Strap
- #98 1 1/4"x30" Hame Strap
- #99 1 1/4"x36" Hame Strap

DELUXE TEAM HARNESS

MADE WITH POLISHED SS SPOTS

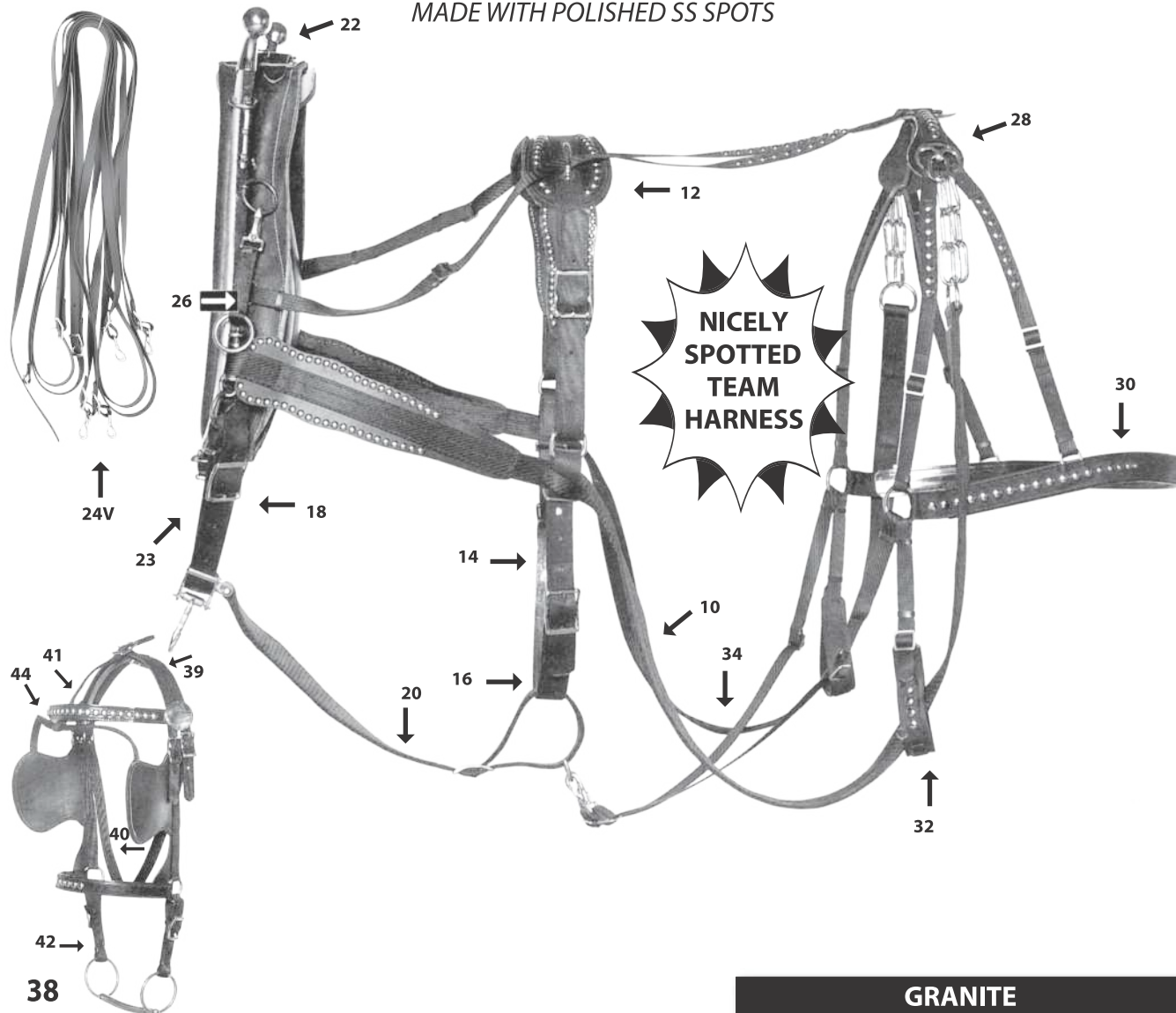

DELUXE TEAM HARNESS

This harness is made of all stainless steel hardware, with a lot of SS spots. Included are #705 black chrome hames. Good choice for work but will also work well for parades, sleigh rides, etc.

STANDARD PARTS

- #705 Hames Black Chrome
- #10 Traces
- #12 Back Bands
- #14 Billets
- #16 Belly Bands
- #18 Breast Straps
- #20 Martingales (#1616 snap)
- #22 Hame Straps
- #23 Hame Straps w/clip
- #24V Lines (Beta)
- #26 Spreads

- #28 Breaching Tops
- #30 Breaching Seats
- #32 Trace Carriers
- #34 Hold Backs
- #38 Bridle
- #39 Crown
- #40 Throat Latch
- #41 Blind Stays
- #42 Bit Straps
- #44 Brow Band

Collars are not included in price.

GRANITE		
MODEL #	SIZE	HAME#
410	Draft 1600-2200lb	705
482	Horse 800-1300lb	705P
454	Pony	705P
456	Miniature	705M
BIOTHANE		
710	Draft 1600-2200lb	705
680	Horse 800-1300lb	705P
NYLON		
210	Draft 1600-2200lb	705
580	Horse 800-1300lb	705P
582	Pony	705P
935	Miniature	705M

OPTIONAL PARTS

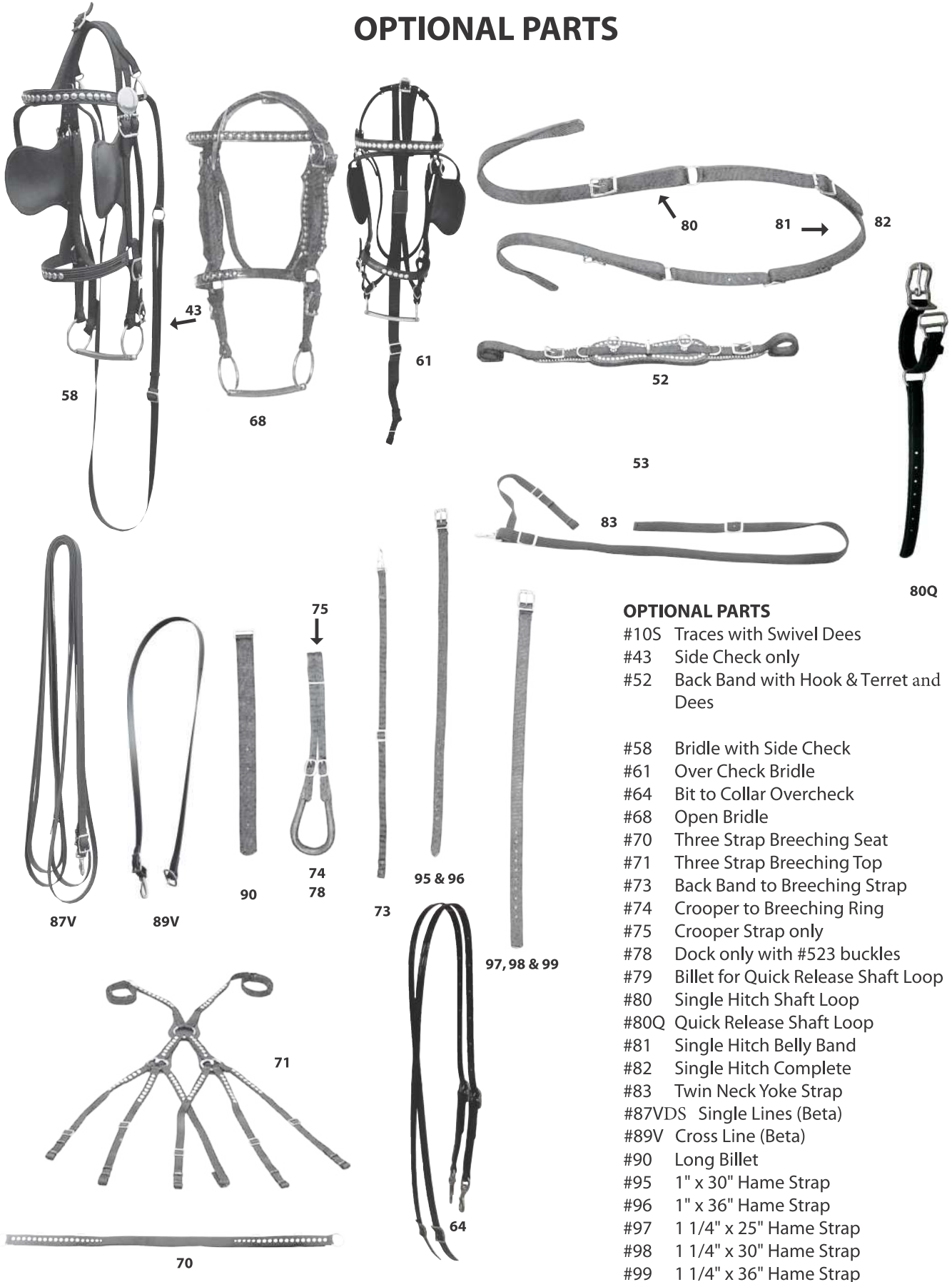

OPTIONAL PARTS

- #10S Traces with Swivel Dees
- #43 Side Check only
- #52 Back Band with Hook & Terret and Dees

- #58 Bridle with Side Check
- #61 Over Check Bridle
- #64 Bit to Collar Overcheck
- #68 Open Bridle
- #70 Three Strap Breaching Seat
- #71 Three Strap Breaching Top
- #73 Back Band to Breaching Strap
- #74 Crooper to Breaching Ring
- #75 Crooper Strap only
- #78 Dock only with #523 buckles
- #79 Billet for Quick Release Shaft Loop
- #80 Single Hitch Shaft Loop
- #80Q Quick Release Shaft Loop
- #81 Single Hitch Belly Band
- #82 Single Hitch Complete
- #83 Twin Neck Yoke Strap
- #87VDS Single Lines (Beta)
- #89V Cross Line (Beta)
- #90 Long Billet
- #95 1" x 30" Hame Strap
- #96 1" x 36" Hame Strap
- #97 1 1/4" x 25" Hame Strap
- #98 1 1/4" x 30" Hame Strap
- #99 1 1/4" x 36" Hame Strap

TEAM WORK HARNESS

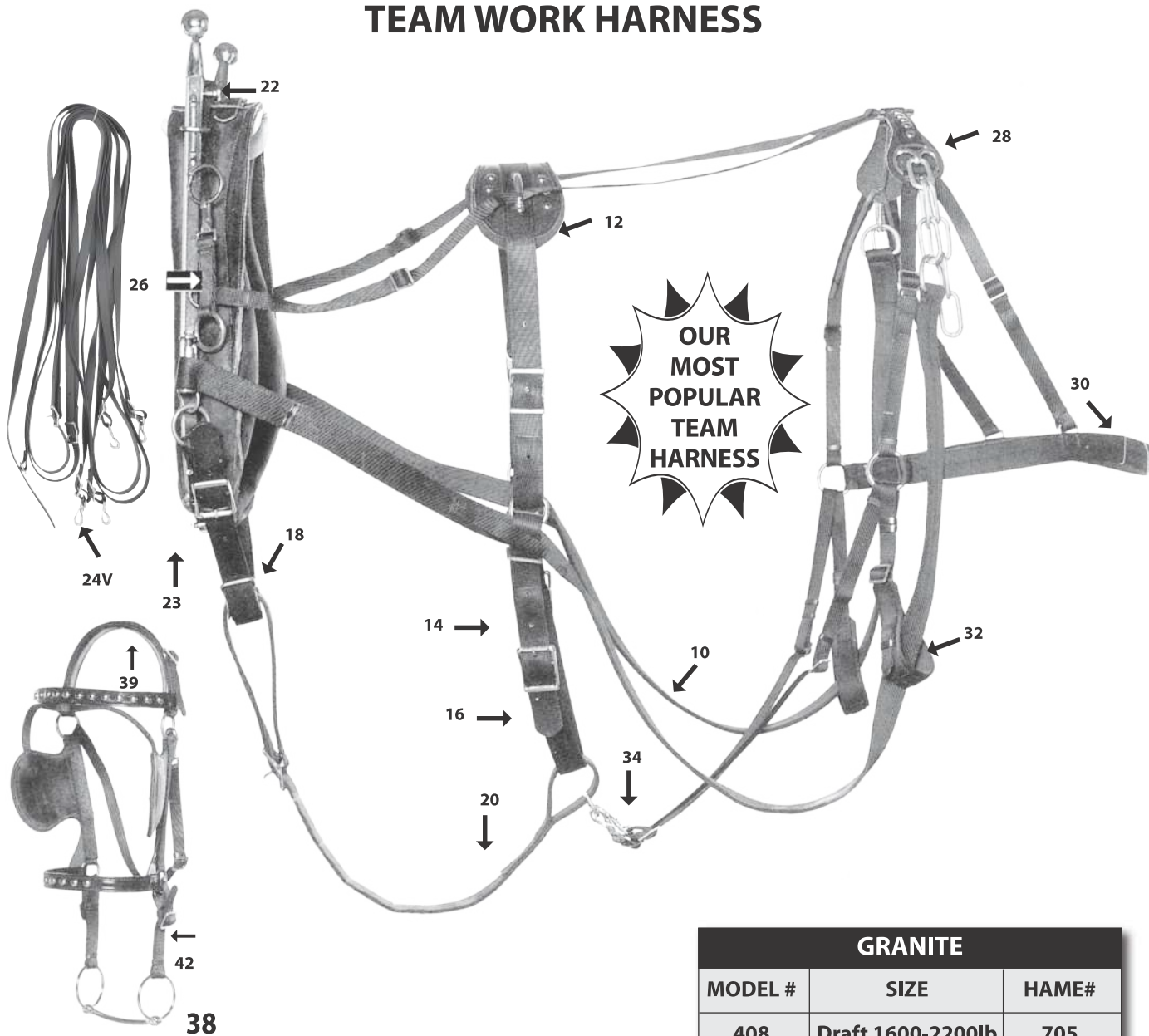

TEAM WORK HARNESS

This harness is a good choice and is very popular for farm work. Has only a few stainless steel spots. Comes with a set of #705 black chrome hames.

STANDARD PARTS

- #705 Hames Black Chrome
- #10 Traces
- #12 Back Bands
- #14 Billets
- #16 Belly Bands
- #18 Breast Straps
- #20 Martingales
- #22 Hame Strap
- #23 Hame Straps w/clip
- #24V Lines (Beta)

- #26 Spreads
- #28 Breaching Tops
- #30 Breaching Seats
- #32 Trace Carriers
- #34 Hold Backs
- #38 Bridle
- #39 Crown
- #42 Bit Straps

Collars are not included in price.

GRANITE		
MODEL #	SIZE	HAME#
408	Draft 1600-2200lb	705
409	Horse 800-1300lb	705P
453	Pony	705P
445	Miniature	705M
BIOTHANE		
215	Draft 1600-2200lb	705
213	Horse 800-1300lb	705P
965	Mini	705M
NYLON		
208	Draft 1600-2200lb	705
575	Horse 800-1300lb	705P
572	Pony	705P
945	Miniature	705M

OPTIONAL PARTS

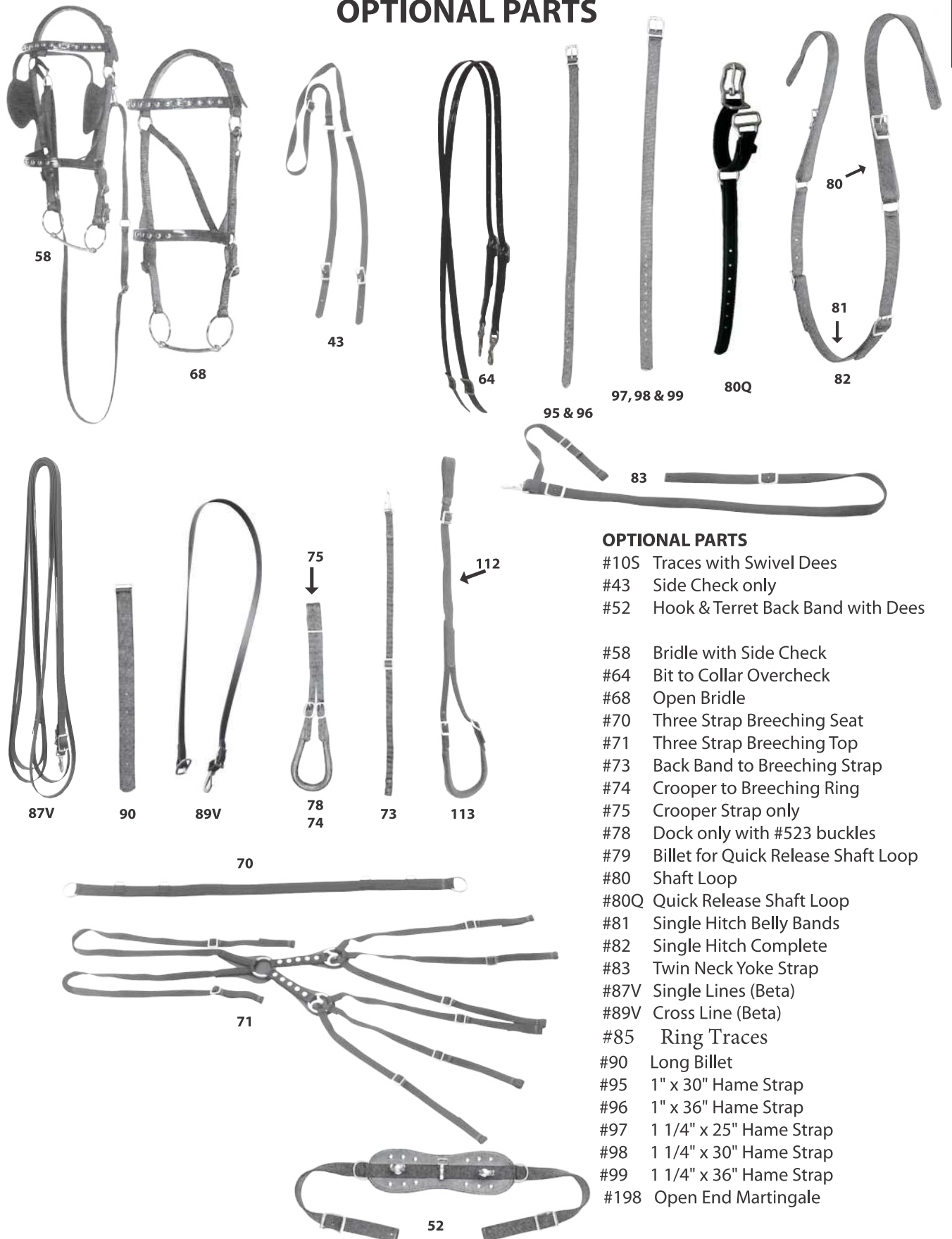

OPTIONAL PARTS

- #105 Traces with Swivel Dees
- #43 Side Check only
- #52 Hook & Terret Back Band with Dees
- #58 Bridle with Side Check
- #64 Bit to Collar Overcheck
- #68 Open Bridle
- #70 Three Strap Breaching Seat
- #71 Three Strap Breaching Top
- #73 Back Band to Breaching Strap
- #74 Crooper to Breaching Ring
- #75 Crooper Strap only
- #78 Dock only with #523 buckles
- #79 Billet for Quick Release Shaft Loop
- #80 Shaft Loop
- #80Q Quick Release Shaft Loop
- #81 Single Hitch Belly Bands
- #82 Single Hitch Complete
- #83 Twin Neck Yoke Strap
- #87V Single Lines (Beta)
- #89V Cross Line (Beta)
- #85 Ring Traces
- #90 Long Billet
- #95 1" x 30" Hame Strap
- #96 1" x 36" Hame Strap
- #97 1 1/4" x 25" Hame Strap
- #98 1 1/4" x 30" Hame Strap
- #99 1 1/4" x 36" Hame Strap
- #198 Open End Martingale

WORK STYLE SINGLE HARNESS SETUP

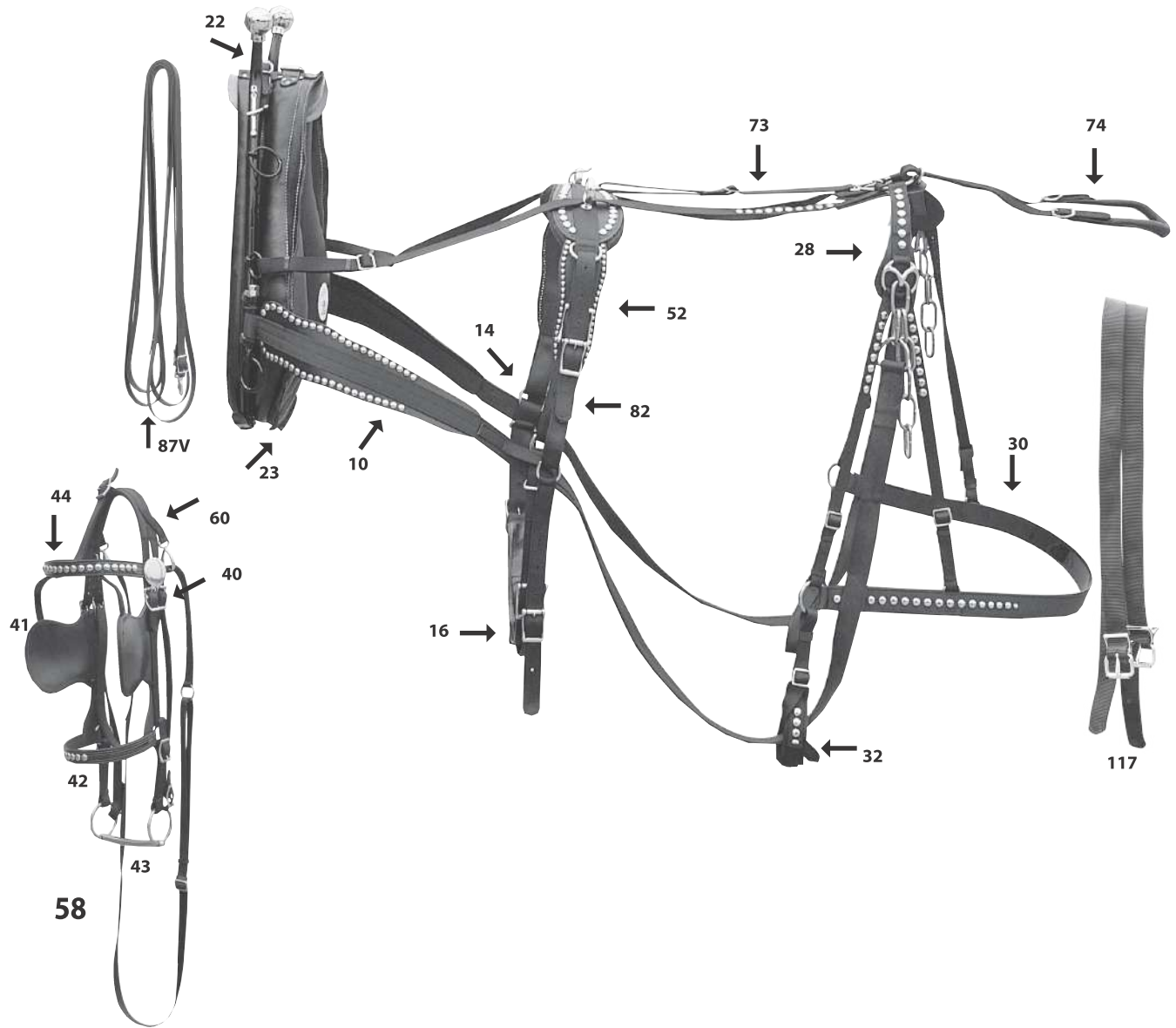

WORK STYLE SINGLE HARNESS SETUP

This single harness setup is available with any of our harnesses, from miniature to draft size. When ordering please specify S (for single) example: 208S / 210S / 580S / 572S. Standard parts can be exchanged for any optional parts.

STANDARD PARTS

- #705 Hames Bk. Chr.
- #10 Traces
- #14 Billets
- #16 Belly Band
- #22 Web Hame Strap
- #23 Bio Hame Strap
- #28 Breeching Top
- #30 Breeching Seat
- #32 Trace Carriers
- #117 Back Holds (for Shafts)
- #52 Hook & Terret Back Band w/Dees

- #58 Sidecheck Bridle
 - #74 Crooper to Breeching Ring
 - #73 Back Band to Breeching Strap
 - #82 Single Hitch Complete
 - #87V Single Lines (Beta)
- Collars are not included in price.**

OPTIONAL PARTS

- #10S Traces with Swivel Dees
- #38 Bridle
- #53 Back Band with Hook & Dees
- #68 Open Bridle
- #70 Three Strap Breeching Seat

- #71 Three Strap Breeching Top
- #90 Long Billet
- #91 St. Billet with Ring
- #95 1"x30" Hame Strap
- #96 1"x36" Hame Strap
- #97 1 1/4"x25" Hame Strap
- #98 1 1/4"x30" Hame Strap
- #99 1 1/4"x36" Hame Strap

NYLON BREECHING

NYLON BREECHING

- 2 Ply nylon strapping with holes and buckles for easier adjustment
- Can be used to replace any regular breechings on all nylon work harnesses
- Draft, Horse, Pony, Miniature

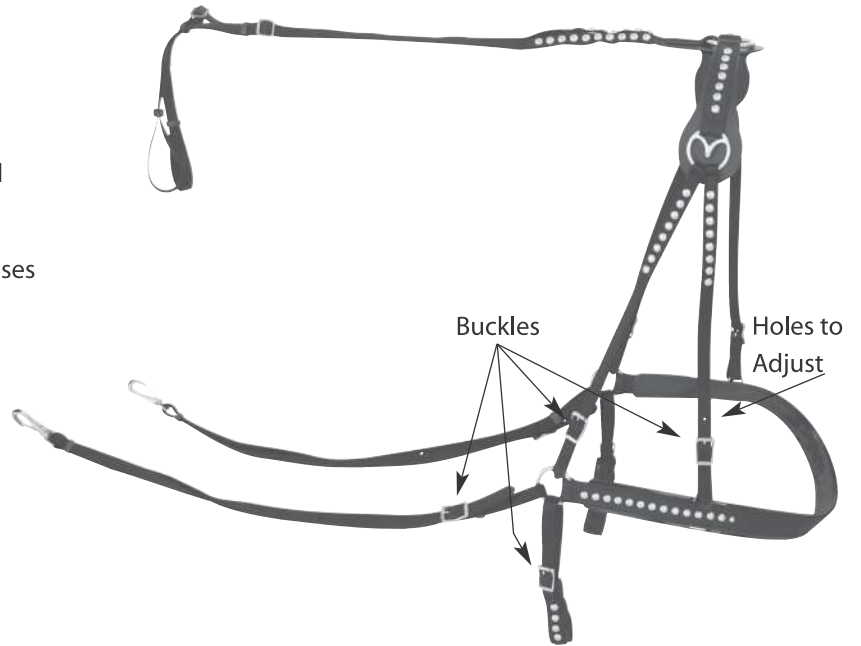

*Photo: Merle Gallant, Sherwood Park, AB
At a horse pull with a #210 Harness.*

DOUBLE DRIVING HARNESS

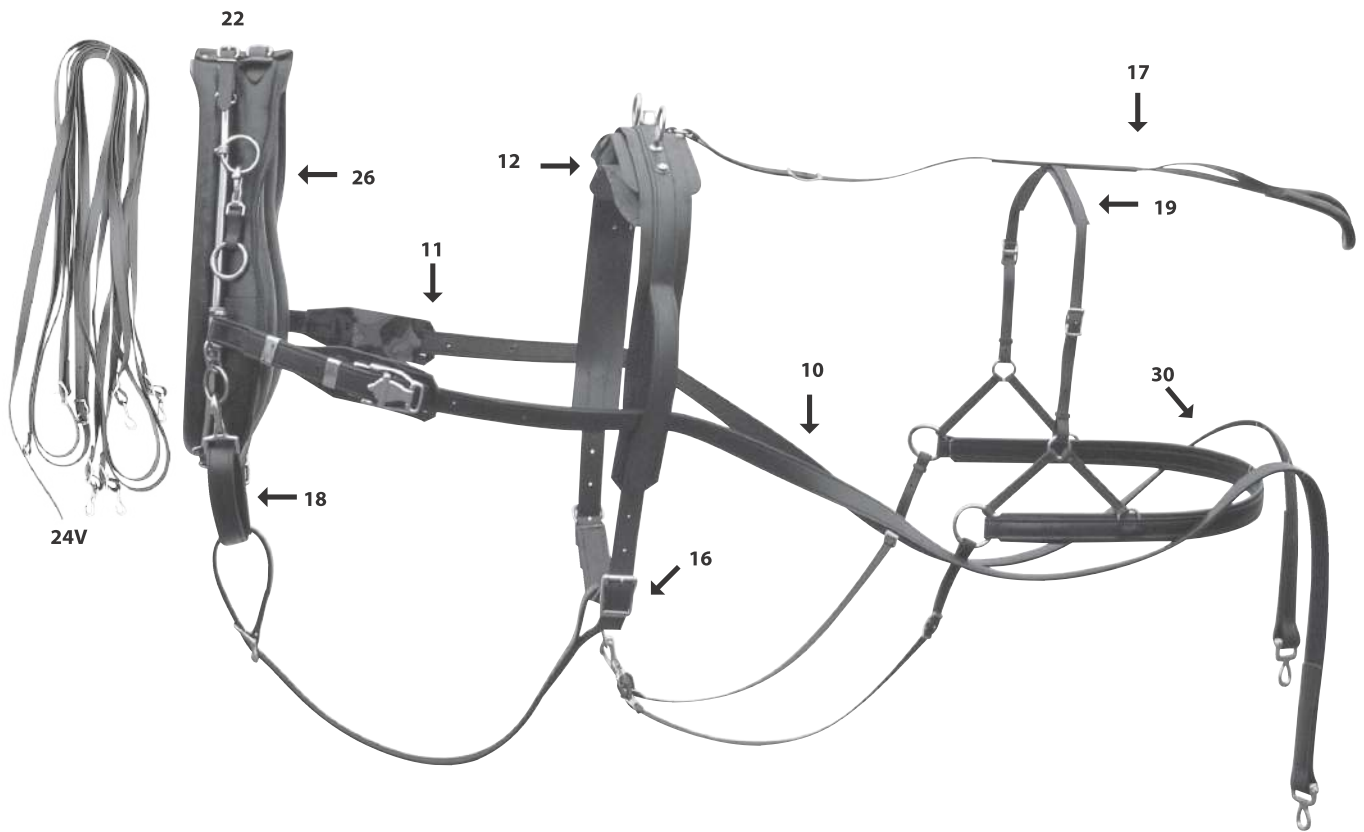

DOUBLE HARNESS

This is our carriage harness or double driving harness. It is a great choice for carriage, wagon and can also be used for field work. It is made from all stainless steel hardware and has rolled belly band and breeching. Can also be rigged up for single driving and your choice of hames or breast collar.

STANDARD PARTS

- #760 Hames
- #10 Traces
- #11 Trace Fronts
- #12 Back Bands
- #16 Belly Bands
- #17 Crooper & Back Strap
- #18 Breast Straps
- #19 Hip Straps
- #20 Martingales
- #22 Hame Straps
- #24 Lines
- #26 Spreads
- #30 Breeching Seat

- #34 Hold Backs
 - #40 Throat Latch
 - #41 Blind Stays
 - #44 Brow Band
 - #61 Overcheck Bridle
 - #62 Overcheck
 - #63 Overcheck Crown
- Collars are not included in price.**

LEATHER		
MODEL #	SIZE	HAME#
250	Horse 800-1300lb	760/774 or Breast Collar
GRANITE		
485	Horse 800-1300lb	760/774 or Breast Collar
469	Pony	774 or Breast Collar
487	Miniature	774 or Breast Collar
BIOTHANE		
285	Horse 800-1300lb	760/774 or Breast Collar
289	Pony	774 or Breast Collar
287	Miniature	774 or Breast Collar
NYLON		
275	Horse 800-1300lb	760/774 or Breast Collar
819	Pony	774 or Breast Collar
816	Miniature	774 or Breast Collar

DOUBLE DRIVING OPTIONAL PARTS

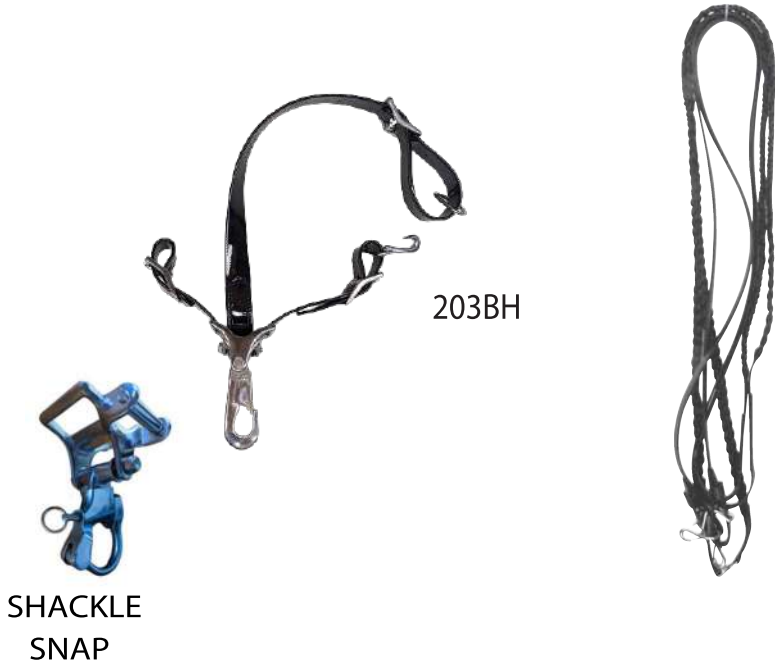
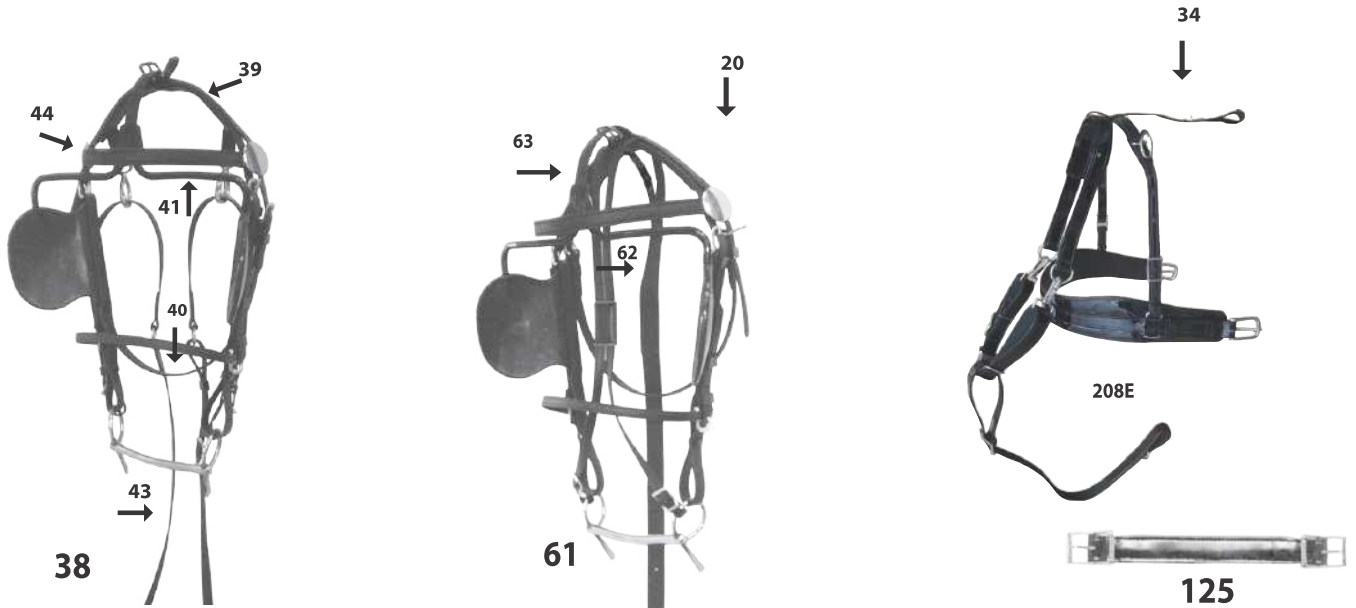

SHACKLE
SNAP

203BH

LINE OPTIONS

- Super Soft
- Pimple Grip
- Plastic Fronts
- Tackled Fronts
- Tackled Backs (wagon)
- 7/8" or 1"

OPTIONAL PARTS

- #38 Sidecheck Bridle
- #61 Overcheck Bridle
- #43 Side Checks
- #39 Crown
- #125 Long Belly Band
- #203BH Snaps for NeckYoke
- #208E Double Breastcollar

SINGLE DRIVING HARNESS

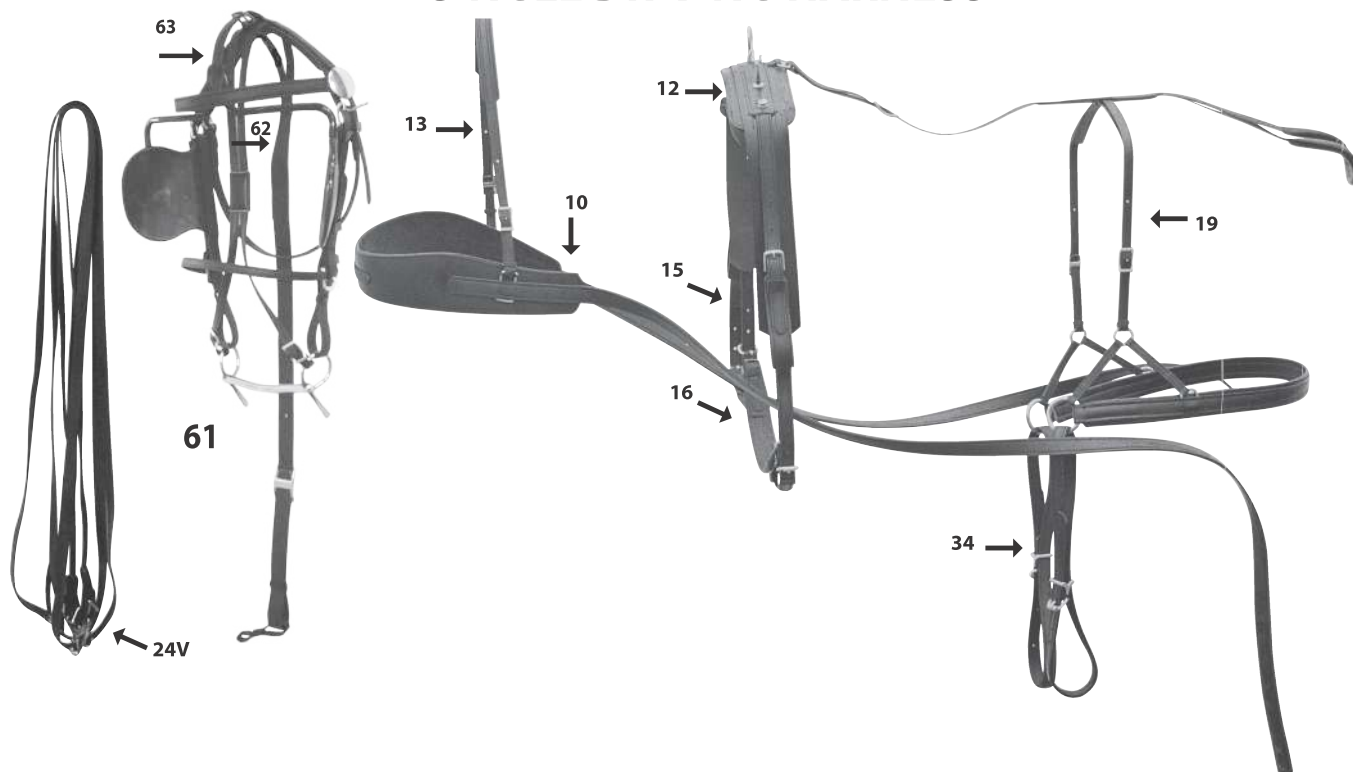

SINGLE DRIVING HARNESS

This harness is made of stainless steel hardware. Made for heavy work or pleasure driving, breast collar or hame style. Padded belly band, breast collar and breeching seat.

BREAST COLLAR STYLE STANDARD PARTS

- #10 Breast Collar & Traces
- #12 Back Band or Saddle
- #13 Neck Strap
- #15 Shaft Loop
- #16 Belly Band
- #17 Crooper & Back Strap
- #19 Hip Strap
- #24 Lines
- #30 Breeching Seat
- #34 Hold Backs
- #40 Throat Latch
- #43 Side Check
- #44 Brow Band
- #61 Overcheck Bridle
- #62 Overcheck
- #63 Overcheck Crown

HAME STYLE STANDARD PARTS

- #774S S.S. Bolt Style Hames
- #12 Back Band
- #15 Shaft Loop
- #16 Belly Band
- #17 Crooper & Back Strap
- #19 Hip Strap
- #24 Lines
- #30 Breeching Seat
- #34 Hold Backs
- #61 Bridle
- #105 Hame Strap with Post
- #106 Hame Straps
- #134 Bolt Style Traces

Please Note: We also stock this harness in horse size with all stainless steel loops and with all SS Floral buckles and loops in Biothane

LEATHER		
MODEL #	SIZE	HAME#
220	Draft 1600-2200lb	774 or Breast Collar
120	Horse 800-1300lb	774 or Breast Collar
GRANITE		
437	Draft 1600-2200lb	774 or Breast Collar
417	Horse 800-1300lb	774 or Breast Collar
415	Cob 600-800lb	774 or Breast Collar
413	Pony	774 or Breast Collar
418	Miniature	774 or Breast Collar
BIOTHANE		
217	Draft 1600-2200lb	774 or Breast Collar
117	Horse 800-1300lb	774 or Breast Collar
717	Cob 600-800lb	774 or Breast Collar
317	Pony	774 or Breast Collar
118	Miniature	774 or Breast Collar
NYLON		
112	Draft 1600-2200lb	774 or Breast Collar
115	Horse 800-1300lb	774 or Breast Collar
114	Cob 600-800lb	774 or Breast Collar
113	Pony	774 or Breast Collar
116	Miniature	774 or Breast Collar

OPTIONAL PARTS

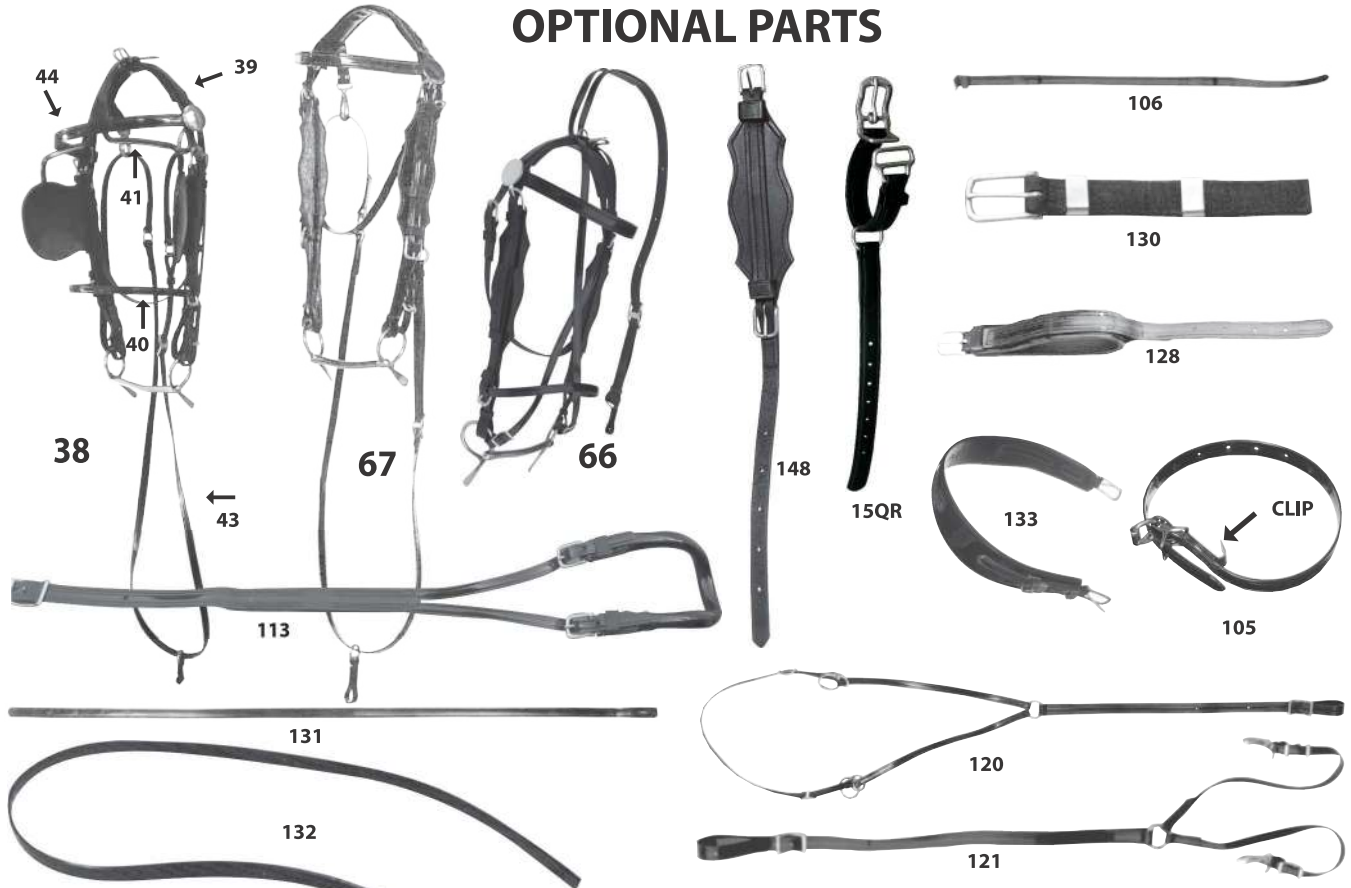

OPTIONAL PARTS

- #10C Deep Curved Breast Collar
- #10CS Deep Curved Breast Collar Split
- #10SP Split Breast Collar
- #250010G-15 Quick Release Shaft Loops
- #16E Elastic Belly Band
- #24VH78 7/8" X 15FT Beta Lines
- #24VRHS Beta Lines W/Grip Hand Holds
- #38 Bridle
- #39 Crown
- #43 Side Check
- #66 Open Overcheck Bridle
- #67 Open Side Check Bridle
- #78 Dock With Buckle
- #105 Hame Strap with Clip
- #106 3/4" x 22" Biothane Hame Strap
- #113 Back Strap With Buckle Dock
- #120 Four Ring Martingale
- #121 Double Snap Martingale
- #122 Short Martingale
- #128 Extra Large Shaft Loop
- #130 Trace Front
- #131 Pointed Trace
- #132 Straight Through Trace
- #133 Breast Collar w/#4L Buckles
- #134 Bolt Style Trace
- #144 3/4" Vinyl Lines



- #140 Bolt Draft Trace Fronts
- #117 1 1/4" Hold Back
- #127 Sulky Style Shaft Loop
- #123 Wrap Around Belly Band
- #124 Wrap Around Piece Only
- #125 Long Belly Band
- #135 Braided Lines (Leather Only)
- #139 Full Around Nose Band
- #148 Flared Cheeks
- #154 Spotted Brow Band
- #154DC Diamond Spotted Brow Band
- #155 1/4" Chain Brow Band (With Red, Blue, White or Black Trim)

BIOTHANE CHUCKWAGON HARNESS

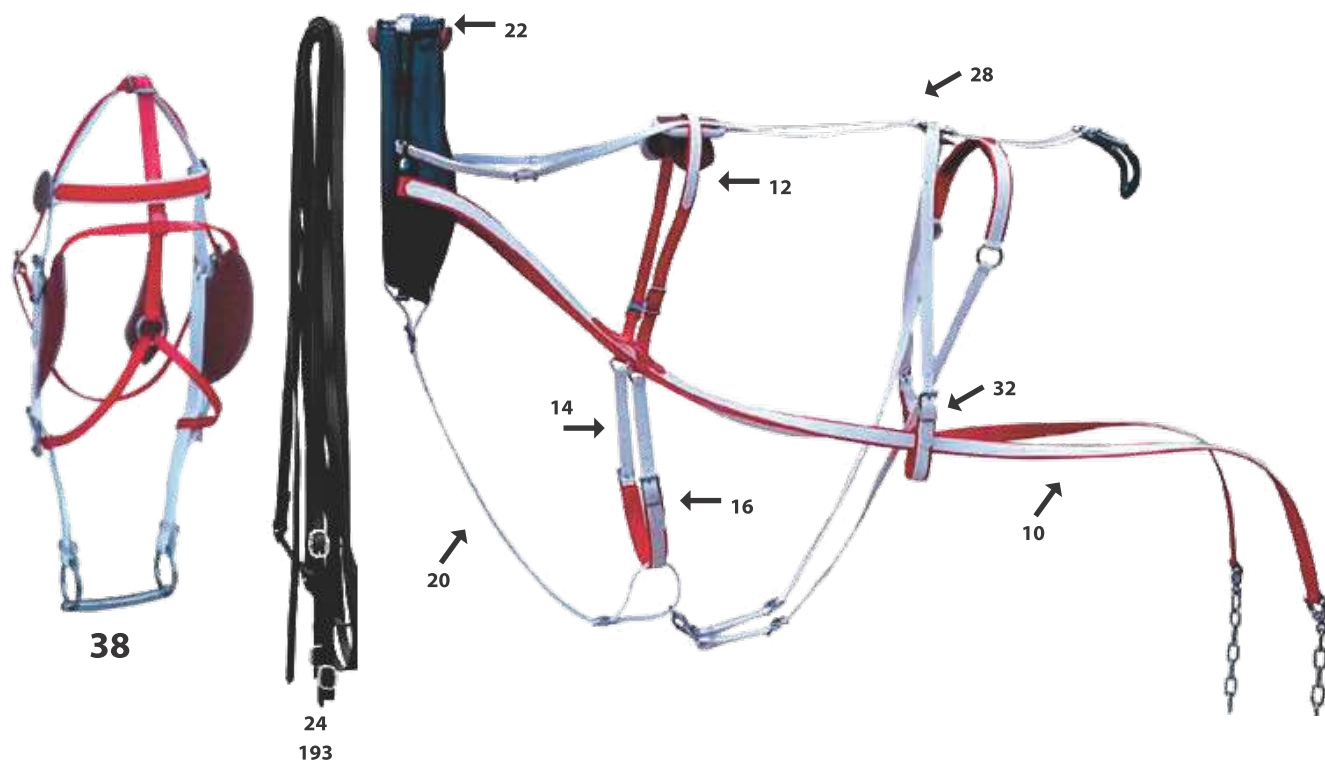

#556

CHUCKWAGON HARNESS (MADE TO ORDER ONLY)

This harness is made for the famous chuckwagon racers, built with quality bioplastics and stainless steel hardware. Can be made with any combined or all one colour. Comes standard with 735 black hames and beta lines. (Available in all sizes, from mini to horse size).

STANDARD PARTS

- #735 Hames Black is Standard
- #10 Traces
- #12 Back Band
- #14 Billets
- #16 Belly Band
- #18 Pole Strap
- #20 Martingale
- #22 Hame Straps
- #24 Hame Straps
- #28 Breeching
- #32 Trace Carrier
- #38 Bridle
- #193 Lead Lines



Photo: Matt Calver

SINGLE OR DOUBLE GRANITE MARATHON HARNESS

(Made to order only)

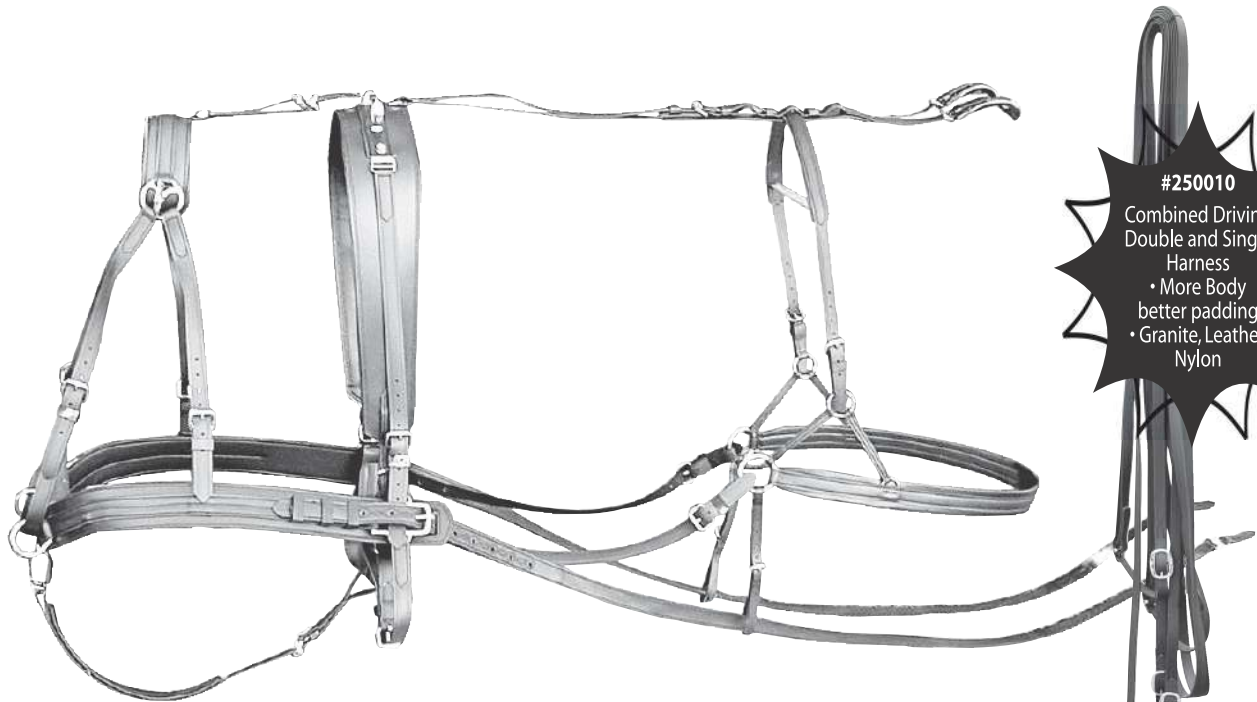

#250010
Combined Driving
Double and Single
Harness
• More Body
better padding
• Granite, Leather,
Nylon

This harness is very tough, durable and has lots of adjustments. Made with granite material and stainless steel hardware. Can be made to fit any size horse, please specify when ordering.

↑
250010-24V

OPTIONAL PARTS



38 BRIDLE



250010-87V
Single Lines



250010-15QR
Quick Release Shaft Loops



250010-62
Overcheck

OPTIONAL NYLON TRACES

NOTE: available in biothane, granite or leather as special order.



#209-54 2 Ply Trace (no Flare)
#209-54F 2 Ply Trace (with Flare)
#209-62 3 Ply Trace (no Flare)
#209-62F 3 Ply Trace (with Flare)



#209-55F 2 Ply Trace (with Flare)
#209-63F 3 Ply Trace (with Flare)



#209-55 2 Ply Trace (no Flare)
#209-63 3 Ply Trace (no Flare)



#209-53 2 Ply Trace (no Flare)
#209-53F 2 Ply Trace (with Flare)
#209-61 3 Ply Trace (no Flare)
#209-61F 3 Ply Trace (with Flare)

NEW FEATURE

Soft touch lining available for inside of nylon traces — very comfortable for the horse.
LOOKS LIKE LEATHER, FEELS LIKE LEATHER
 Available on all nylon traces.



#209-57 3 Ply Trace (with Flare)



#209-56 3 Ply Trace (no Flare)



#209-65 3 Ply x 66"
#209-67 3 Ply x 56"



#209-65F 3 Ply x 66"
#209-67F 3 Ply x 56" (with Flare)

BUSH TRACES

NOTE: Above traces available in biothane, granite or leather as special order.

HARNESS DECORATIONS

**#22 PLAIN
FACE DROP
Draft Size**

- #22B Biothane
- #22G Granite
- #22L Leather
- Horse Size**
- #23B Biothane
- #23G Granite
- #23L Leather
- Pony Size**
- #22BP Biothane
- #22GP Granite
- #22LP Leather
- Mini Size**
- #22BM Biothane
- #22GM Granite
- #22LM Leather
- Brass or POL SS



**#24 SPOTTED
FACE DROP
Draft Size**

- #24B Biothane
- #24G Granite
- #24L Leather
- Horse Size**
- #26B Biothane
- #26G Granite
- #26L Leather
- Pony Size**
- #24BP Biothane
- #24GP Granite
- #24LP Leather
- Mini Size**
- #24BM Biothane
- #24GM Granite
- #24LM Leather
- Brass or POL SS



**#1105
MARTINGALE
DROPS**

- #1105B Biothane
- #1105G Granite
- #1105L Leather
- Brass or POL SS



**#1108 1-SIDED
KIDNEY DROPS**

- #1108B Biothane
- #1108G Granite
- #1108L Leather
- Brass or POL SS



**#1114L
LEATHER FRONT SHIELDS
#1114B
BIOTHANE FRONT SHIELDS
#1114G
GRANITE FRONT SHIELDS**

Really dresses those pulling and parade teams (just snap on hames). Use your own name or horse's name. Choose your ornaments. Brass or POL SS.



**#1101
HAME COVERS**

- In Leather, Biothane or Granite
- Brass or POL SS



**#1118
TAIL DROP**

- #1118B Biothane
- #1118G Granite
- #1118L Leather
- Brass or POL SS



**#1110 DOUBLE
KIDNEY DROPS**

- #1110B Biothane
- #1110G Granite
- #1110L Leather
- Brass or POL SS

HARNESS MISCELLANEOUS



**#136-C
CROOPER**



#136-B Backing only

**#136-BB
Belly Band only**

**#136
TRAINING AND BITING
HARNESS**

Made of tough nylon and stainless hardware, available with crooper. Ankle straps are extra. Fits from 800-2000 lb. horse (Available complete or in parts)



**#685S SHAFT TYPE
MANURE BAG**

Durable strong construction. Straps onto your cross piece of your shafts and snaps onto the breeching of your harness.



**#136
ANKLE STRAP**
#136H Horse size
#136D Draft size



**#685SD
MANURE BAG
WITH SNAP &
DEE**

- Draft
- Pony
- Horse
- Mini



#685MANURE BAG
Durable construction and fully adjustable.

- #685H
MANURE BAG
HORSE SIZE**
- #685P
MANURE BAG
PONY SIZE**
- #685M
MANURE BAG
MINI SIZE**



**#685-RIDING
MANURE BAG**

Made to attach to saddles while riding.

SPREADERS ETC.

#1100 RING & SLIDE LOOP

- BR, POL SS or Coloured
 • Beta or Leather only
 • Draft or Horse Size

#1103 FULLY SPOTTED

- BR, POL SS
 • Leather, Biothane or Granite
 • Draft & Horse Size

These spreaders attach to hame ring and other end back to breeching ring on hip of horse. They hang on outside of each horse on a team.



#1135 LEADER MARTINGALE

- Come in Leather, Granite or Biothane
 • Plain or Diamond Chain or Spotted
 • Brass or POL SS



- #102L (230-26) LEATHER DOUBLE SPREADS**
#102B (235-26) BIOTHANE DOUBLE SPREADS
#102G (435-26) GRANITE DOUBLE SPREADS
#102P PONY SIZE DOUBLE SPREADS
 BR, POL SS, or coloured



- #103L LONG SINGLE LEATHER SPREADS**
#103B BIO LONG SINGLE SPREADS
#103G LONG SINGLE GRANITE SPREADS
#103P PONY SIZE DOUBLE SPREADS
 BR, POL SS, or coloured



- #100L SHORT SINGLE SPREADS**
#100B SHORT BIOTHANE SINGLE SPREADS
#100P SHORT PONY SIZE SINGLE SPREADS
 BR, POL SS, or coloured



- #1115B Biothane CROSS LINE DROP**
#1115L Leather CROSS LINE DROP
#1115G Granite CROSS LINE DROP
 BR, POL SS

#1119 FEATHER PLUMES

- A beautiful 6" feather bridle plume.
 • Now comes with a spring stainless steel base to avoid breakage
 • Black, Blue, Green, Red, White and Yellow in stock
 • Other colours and 10" are also available



#1117 HAIR TASSELS

- An old fashioned item that is back!!
 • 9" Horse hair tassel with non rust hardware
 • Spring on stem to avoid breakage
 • Available in Red, Blue, Green and Yellow



NEW



#1116S LINE DROP

- 5" Spotted Heart
 • Available in Black, Blue, White, Green or Red

HOW TO MEASURE A HORSE FOR A COLLAR

Length from top to base of neck at proper position of collar. Line should be straight, not conforming to the horse's body. If possible, measure a collar which fits the horse, using the inside dimensions of the collar, as shown.

You can make a makeshift measure by using two carpenter squares. (If you only have one cut another out of cardboard.)

Place them together to form a "C" in front of the withers, place the bottom of the "C" two inches in front of the shoulders. Be sure to allow finger room at the base of the throat. Measure the inside of the "C" to obtain the size.

Another option is to measure the circumference of the widest part of the front leg (usually under the arm pit). This has been giving us the collar size within a inch or so.

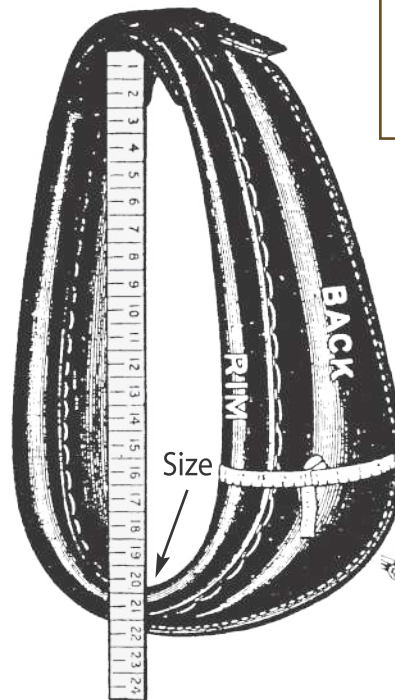
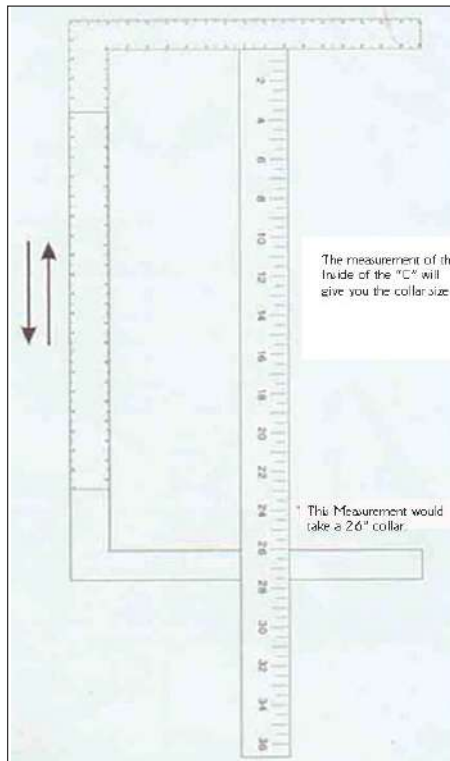

Hames must be so fitted that hame tug comes on centre of draft.



#3007 HORSE NECK MEASURE

- A handy tool to help determine the size of collar needed !
- Wooden handle with steel adjusting bar
- Measures collar sizes from 15" - 28"

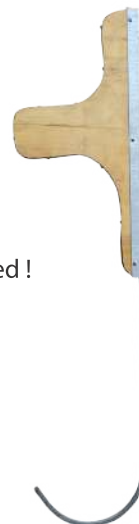

FIELD COLLARS

All these collars are stocked in half Sweeny. Others are available on request. We can also do cloth faced collars. If you are looking for a size not listed please call to see if available. Please allow 2-4 weeks for special orders.



NEW

#99 LEATHER DRAFT COLLAR

This collar is well built, has top quality leather inside and outside, plus leather lacing for a longer life!
• A very good collar for the price!



NEW

#4011 SYNTHETIC DRAFT COLLARS

- Made with durable microfiber material
- Will not dry out
- No oiling needed
- Less expensive than leather
- Sizes 20" – 29"



NEW

#99A LEATHER ADJUSTABLE DRAFT COLLAR

- Top quality leather inside and outside, plus leather lacing for longer wear.
- A well made collar at a reasonable price!
- Sizes from 19" to 30"



NEW

#4011A ADJUSTABLE SYNTHETIC DRAFT COLLAR

- Made with durable microfiber material
- Will not dry out
 - No oiling needed
 - Less expensive than leather
 - Sizes 20" -28"



#74S FIELD COLLAR

- A good quality Canadian made field collar.
- Made with top quality full grain leather
 - Black rim and back with a red facing
 - Stitched with nylon thread
 - No choke throat design
 - Also has extra wear lugs
 - A good choice for farm work or parades etc.
 - Sizes 20"-30"



#74H PULLING COLLAR

- A good quality Canadian made pulling and logging collar.
- Designed for heavy duty pulling and logging collar
 - Made with top quality full grain leather
 - Black rim and back with a red facing
 - Laced outer edge with brown lace leather
 - Double buckles on top
 - No choke throat design
 - Also has an extra wear lug
 - Sizes 24"-30"



#74SA ADJUSTABLE COLLAR

- The same make as the 74S collar only with black facing.
- Adjusts 3 sizes per collar
 - Sizes 18" - 28"
 - Please allow 2-3 weeks for delivery

#530 PULLING COLLAR

Not a Stock Item. Orders may have longer lead times.

- Made by Coblantz Collar
- Superior quality top grain natural colour leather back and rim
- Chrome oil tanned brown facing-will not absorb sweat
- Laced outer edge and hame bed with strong oil tanned brown lacing
- No choke throat design
- Double 1 1/4" buckle top
- Extra heavy wear lugs
- Comes in half Sweeney
- Sizes 24"-30"



#72AC ADJUSTABLE COLLAR CAP

- Replacement Cap for 72A Collars



DRIVING COLLARS



#16L LIGHT FIELD COLLAR
A full grain black leather all purpose collar.

- Ideal for carriage or light work
- Chrome oil tanned black facing- will not absorb sweat
- Stitched with heavy nylon thread
- Sizes 15"-24"



#10G BUGGY COLLAR
A high quality, top grain, black leather back and rim.

- Chrome oil tanned black facing
- Will not absorb sweat
- Stitched with heavy nylon thread
- A nice buggy or carriage collar
- In full face as shown
- Also available in Tan. (Allow 2-4 weeks)
- Sizes 10"-24"



#4019 ALL PURPOSE SYNTHETIC COLLAR

- Made with durable microfiber material
- Will not dry out
- No oiling needed
- Less expensive than leather
- Excellent for medium duty use
- Sizes from 18" – 24"



#4018 HORSE, PONY SYNTHETIC COLLAR

- Most popular light weight collar !
- Made with durable microfiber material
- Will not dry out
- No oiling needed
- Less expensive than leather
- Sizes 10" – 23"



VINYL COLLAR BOTTOM SWEAT PAD

- A foam pad covered with marine grade vinyl
- This pad clips around bottom of collar and stays in place when opening or closing collar

#316 Horse size 18" - 23"
#316D Draft Sizes 23" - 28"

NECK COLLAR PADS



#525 FELT NECK PAD

- For more padding on neck
- Fastens on with straps
- 8 1/4" x 13"



#525D DEER HAIR NECK PAD

- A White and Blue striped pad
- Fastens on with straps
- 8 3/4" x 13"



#525V VINYL NECK PAD
#525VCL Vinyl Neck Pad With Clips

- Foam pad covered with marine grade black vinyl
- Great for horses with sore necks
- 8 1/4" x 12"

SWEAT PADS

Note : Order Pads Two Sizes Larger Than Collar Size!



YELLOW DEER HAIR SWEAT PAD
 • The old time Yellow pad with a Red edge
 • Stuffed with deer hair
 • This pad very popular with pullers

#303 EXTRA WIDE SWEAT PAD



#304 VINYL SWEAT PAD
 • A foam pad covered with marine grade vinyl
 • Designed with no wrinkles on top
 • Will help heal sores while working
 • Black in stock
 • Can be ordered in Blue, Burgundy, Green or Red
 • 20" - 31"

#305 EXTRA WIDE VINYL SWEAT PAD
 • Same as the above only wider
 • 24" - 34"

#309 BUGGY SIZE SWEAT PAD
 • Same as above except narrower for buggy collars
 • 18" - 23"



#300 DEER HAIR SWEAT PAD
 • Durable Blue and White striped cloth
 • Filled with deer hair
 • 18" - 31"
 • Also available in Blue, Green and Red

#301 EXTRA WIDE DEER HAIR SWEAT PAD
 • 24" - 34"
 • Also available in Blue, Green and Red



#315 ROLLED VINYL SWEAT PAD
 • A foam pad with a marine grade vinyl cover
 • Designed with no clips
 • This pad has a rim to take place of clips so it will not slip out of the collar
 • And also two hook & loop straps on left side to hold it to the collar when it is not in use and nylon straps on right side to fasten under the hame
 • Will help heal sores while working
 • Black in stock
 • 23" - 26"

#314 BUGGY ROLLED VINYL SWEAT PAD
 • Same as above pad but only narrower for buggy collars
 • 18" - 23"



#310 FELT SWEAT PAD
 • Made with 1/2" black polyester felt
 • 22"-30"

#308 BUGGY SIZE SWEAT PAD
 • Made with 1/2" top quality black polyester felt
 • 18" - 24"

#312 COLORED BORG COVERED PAD
 • A felt pad covered with borg (fake fur)
 • 22" - 30"

• Available in Black, Blue, Burgundy, Green and Red

#313 BUGGY SIZE SWEAT PAD
 • Same as above except narrower for buggy collars
 • 18" - 24"



NEOPRENE SWEAT PAD
 • Foam padding with neoprene against the horse
 • Designed with no wrinkles on top
 • 23"-30"
 • Tops available in a variety of colors

#343 NEO/CRUSHED VELVET TOP EXTRA WIDE
#344 NEO/VINYL TOP REGULAR WIDTH

SWEAT PADS BACK BAND PADS



BORG COVERED PADS

These pads are made from foam with a fake fur covering. We stock Black, Blue, Burgundy, Brown, Green, Hunter Green, Red and Yellow. There are other colours available. Please call and ask.



#402 SHOW DRAFT SIZE PAD

- Has slots to slide back band through
- 11" x 30"

#401 DRAFT SIZE PAD

- Has slots to slide back band through
- 9" x 22"

#400 HORSE SIZE PAD

- Fastens with hook & loop fasteners
- 7" x 21"

#400P PONY SIZE PAD

- Fastens with hook & loop fasteners
- 5" x 16 1/2"

#400M MINI SIZE PAD

- Fastens with hook & loop fasteners
- 4 1/2" x 13 1/2"

BACKBAND PADS

These pads are excellent for horses with sore backs. Covered with Neoprene on both sides. Fastens with hook & loop fasteners.



#406NM MINI SIZE

- 4 1/2" x 13 1/2"

#406NP PONY SIZE

- 5" x 6 1/2"

#406NH HORSE SIZE

- 6" x 18"

#406ND DRAFT SIZE

- 9" x 22 1/2"

#406VH HORSE SIZE

- Smooth vinyl

- 6" x 18"

- Black, Blue, Burgundy, Green and Red

#406NB DELUXE NEOPRENE PAD

- Neoprene pad with Borg (Fake Fur) trim
- Fastens with hook & loop fasteners
- 6 1/4" x 18"
- Black, Blue, Burgundy, Kelly Green, Hunter Green, Red
- Specify colour when ordering!



BREASTCOLLAR PADS



FAKE FUR PADS

These pads are made from foam with a fake fur covering. We stock Black, Blue, Burgundy, Brown, Green, Hunter Green, Red and Yellow. There are other colours available. Please call and ask.

#403M MINI SIZE PAD

- 3 3/4" x 25"

#403P PONY SIZE PAD

- 5" x 31"

#403 HORSE SIZE PAD

- 6 1/4" x 36"



NEOPRENE VINYL PADS

These pads are excellent for horses with sore shoulders. Also available for split breast collar

#403NM MINI SIZE

- Fastens with hook & loop fasteners
- 3 1/2" x 24"

#403NP PONY SIZE

- Fastens with hook & loop fasteners
- 4 1/2" x 30"

#403NH HORSE SIZE

- Fastens with nylon straps & buckles
- 6 1/2" x 38 1/2"

#403VH VINYL HORSE BREAST COLLAR PAD

- Made from marine grade vinyl
- Fastens with straps and buckles
- Black, Blue, Burgundy, Green, and Red
- #403VH-S for split breastcollar



#403NB DELUXE HORSE SIZE PAD

- Neoprene pad with a fake fur trim
- Fastens with hook & loop fasteners
- 6 1/2" x 38 1/2"
- Black, Blue, Burgundy, Kelly Green, Hunter Green and Red



CURVED PADS



- Pads are curved to fit breast collars
- Available in Neo/Fake Fur, Neoprene, or Vinyl
- Also available for split breast Black, Blue, Burgundy, Green, and Red

#4300 Curved Vinyl Pads

#4304 Curved Neoprene Pads

#4305 Curved Borg-Neoprene Pads

#4302 Curved Split Vinyl Pads

#4306 Curved Split Neoprene Pads

#4307 Curved Borg-Neoprene Pads

#404VH BREECING SEAT PAD

- Smooth vinyl pad, great for horses that get sores from breeching seat
- Fastens with hook & loop fasteners
- 4 1/2" x 40"



#404 BREECING PAD

- Black borg (Fake Fur) covered foam pad
- Fastens with hook & loop fasteners
- 3 1/4" x 43"

BREECHING PADS

#404N NEOPRENE BREECING PAD

- Great for horses that get sores from breeching seat
- Fastens with hook & loop fasteners
- 4 1/2" x 40"

#404NB DELUXE BREECING PAD

- Same as the above pad but with a black borg (fake fur) trim

FARM / PULLING HAMES

HOW TO MEASURE HAME SIZE



Draft hames come in sizes of every 2 inches.

Example: 26" hames fit on 24", 25", and 26" collar.



VERY HIGH QUALITY
Great for parades, etc.

#510 WOODEN HAMES

- Top quality wood, steam bent for a good fit on collar
- Available in stainless steel, brass and black steel trim
- Smooth finished hickory wood
- 22" - 28" (state collar size)

MADE IN USA



POL SS SHOW QUALITY

#701 COMPETITION PULLING AND LOGGING HAME

- Large hame ball
- 2 1/2" Bolt draft
- POL SS or Black w/SS trim
- 24", 26", 28", 30"



#700 COMPETITION PULLING AND LOGGING HAME

- Black w/Brass hardware
- Black w/Stainless hardware
- Sizes 24", 26", 28", 30", 32", 34"

LIGHT TO HEAVY DRAFT HORSES

NEW & IMPROVED



MORE CURVE AT BOTTOM FOR BETTER FIT TO COLLAR

ALL STAINLESS BALLS, RINGS & SLIDES

#705 FARM OR COMMERCIAL HAME (BOLT DRAFT)

- Black w/Brass trim
- Black w/Stainless trim
- All Chrome
- Sizes 22", 24", 26", 28", 30", 32", 34"

NOW AVAILABLE

- High Polished Stainless Steel
- Sizes 22", 24", 26", 28", 30"

DRIVING HAMES

**PONIES
TO LIGHT
DRIVING
HORSES**



#705P FARM OR COMMERCIAL HAME

- Black w/Brass Trim
- Black w/Chrome Trim
- All Chrome
- Sizes 16", 18", 20", 22", 24"
- 1 1/2" or 2" Bolt Draft
- **High Polished Stainless Steel**
- 18", 20", 22", 24"
- 2" Draft

#735 CHUCK WAGON HAME

- Black paint
- All Chrome
- Sizes 12", 14", 16", 18", 20", 22"
- 1 1/2" Bolt draft
- Solid Line Ring
- Solid Breaching Ring



#760 LOW-TOP ALL STEEL HAME

- Bolt or steeple draft 16" - 24". Black, chrome, galvanized or polished stainless steel.



**#705M
MINIATURE HORSE HAME**

Finely balanced for the very small collars, tubular steel in Black, SS or brass. Sizes 12", 14", 16" and 18"

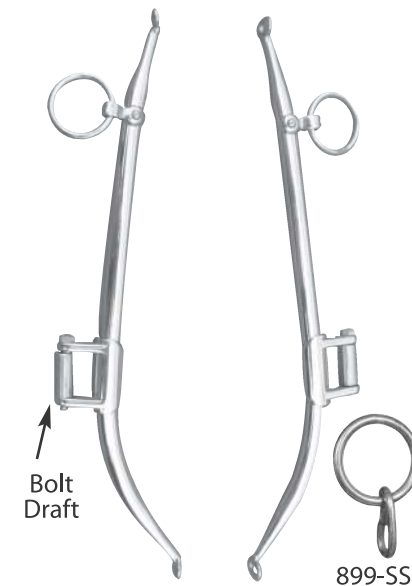

**#774S BOLT DRAFT STAINLESS
STEEL DRIVING HAME**

- Sizes - 17" - 24"

**#774B
BLACK**

- Sizes - 17" - 24"

**#899-SS
BREAST STRAP RINGS**

- To use on 774 Hames

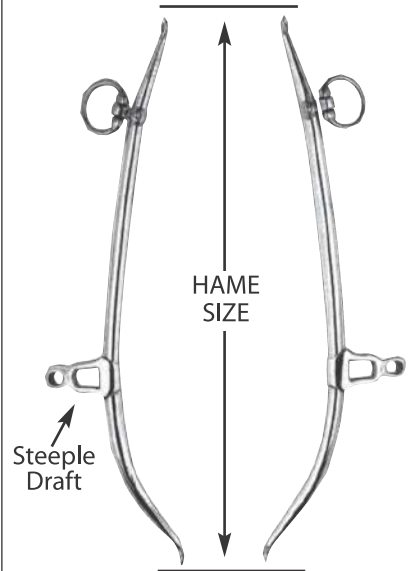

TUBULAR DRIVING HAME

- Half round
- #772S** Stainless steel - 17", 18", 19", 20", 21", 22", 23" and 24"
- #772B** Black - 16", 17", 18", 19", 20", 21" and 22"
- #780** Solid brass or chrome plated - 18", 19", 20", 21" and 22"
- Other sizes available on special order

SHOW HALTERS

These show halters are all made here in our shop with top quality material. A 5 1/2' lead with a 20" chain is included with every halter. White show halters all come with stainless steel hardware, brown show halters with brass hardware.



PLAIN SHOW HALTER

A plain show halter with a single crown.
#236PL Weanling White or Brown Leather
#236GPL Weanling White or Brown Beta
#237PL Yearling White or Brown Leather
#237GPL Yearling White or Brown Beta
#234PL 2 Year Old White or Brown Leather
#234GPL 2 Year Old White or Brown Beta
#238PL Mare/Gelding White or Brown Leather
#238GPL Mare/Gelding White or Brown Beta



SHOW HALTER

A split crown show halter with a throat latch and brow band.
#236 Weanling White or Brown Leather
#236G Weanling White or Brown Beta
#237 Yearling White or Brown Leather
#237G Yearling White or Brown Beta
#234 2 Year Old White or Brown Leather
#234G 2 Year Old White or Brown Beta
#238 Mare/Gelding White or Brown Leather
#238G Mare/Gelding White or Brown Beta



DELUXE SHOW HALTER

A split crown show halter with a throat latch and brow band. Comes with chain on the brow band, nose plate and a swinging toggle on crown.
#236CH Weanling White or Brown Leather
#236GCH Weanling White or Brown Beta
#237CH Yearling White or Brown Leather
#237GCH Yearling White or Brown Beta
#234CH 2 Year Old White or Brown Leather
#234GCH 2 Year Old White or Brown Beta
#238CH Mare/Gelding White or Brown Leather
#238GCH Mare/Gelding White or Brown Beta



STUD SHOW BRIDLE

A split crown show bridle with bit and a 5' lead.
#233 2 Year Old White or Brown Leather
#239 Mature Stud in White or Brown Leather
#233G 2 Year old White or Brown Beta
#239G Mature Stud in White or Brown Beta
Is also available in the Deluxe Model (not Shown)
 With chain brow band, Nose plate and toggle on crown.
#233CH 2 Year Old White or Brown Leather
#239CH Mature Stud in White or Brown Leather
#233GCH 2 Year old White or Brown Beta
#239GCH Mature Stud in White or Brown Beta



COTTON ROPE SHOW HALTER

Made of soft White cotton rope with a lead.
#236R Weanling Size
#237R Yearling Size
#234R 2 Year Old Size
#238R Mare/Geld Size



COTTON SHOW HALTER WITH CHAIN

Made of soft White cotton rope. Comes with a chain lead.
#236RC Weanling Size
#237RC Yearling Size
#234RC 2 Year Old Size
#238RC Mare/Geld Size

SUPPLIES

TIP: When decorating the horse for halter, use 7 flowers in the mane, when decorating for hitch, use 5 flowers per horse. Allow for some spares when ordering! Please ask if needing a colour not listed!



#7096 FOLDING BRAIDING BENCH
A wooden braiding bench. Is a must for every show person! Folds for easy storage. 34" long x 11 1/2" wide x 30" high. Comes unfinished or can be stained to the stain of your choice.



#7098 MANE ROLLS
Double knit mane rolls are made from fabric which is durable, colour fast and easy to braid with. They can be made of one colour or a combination of 2 colours. Machine washable and drip dry for easy care. 1 3/4" x 10". Colours available are Black, Blue, Burgundy, Green, Red, Yellow and White. Other colours available, please call for availability.



#7097 TAIL BOWS
Made from the same fabric as the mane rolls. So very easy to care for and can be made in the same matching colours! Has an elastic band so it can be easily attached to tail. Overall length is 5 1/4" wide x 8" long.

#7099-F FOIL MANE ROLL FLOWERS
Shiny foil flower with a silver bow at the base. We stock Blue, Green and Red. Other colours available, please call for availability.



#7099-P PIPE CLEANER MANE ROLL FLOWERS
These are made from the fuzzy pipe cleaners. With a white centre and bow with a silver sprig. We stock Blue, Green and Red. Other colours available, please call for availability.



#7093 SHOW STICKS
Fiberglass show sticks with a rubber grip handle and a rubber tip. 1/2" x 26" long. Comes in Blue, Red and White.



#7095 TAIL NEEDLE
Stainless steel needle with a eye and a finger hold makes tail tying a breeze. 1/4" thick x 12 1/2" long.

#7099-R ROSE MANE ROLL FLOWERS
Silk rosebuds on a wire stem. We stock Burgundy, Red, White and Yellow. Other colours available, please call for availability.



#7099PT PAPER TOP MANE FLOWERS
These are made out of paper that is stiffened and water resistant. Bows can be one, two or three colours. A basic old style with lots of class. We stock Blue, Green and Red. Other colours are available.



#8090 TAIL SPRIGS
Tail sprigs are ready to be braided into 1/2" of hair on top of tail. Colours: Burgundy & White, Blue & White, Green & White and Red & White. Other colours available, please call for availability.



HALTERS

Please see our selection of nylon and leather halters for all sizes of horses. These are made locally in a range of styles and grades with quality nylon or leather. We also manufacture a wide range of custom halters. So if you need an item not listed ask for a price quote. All halters are available without snaps. Nylon halters are stocked in 5 common colours: Black, Red, Blue, Green and Burgundy with many other colours available. Please call to find out what we have.



#243 ECONOMY 3/4" NYLON HALTER

- Brass plated hardware
- Black, Blue, Burgundy, Green and Red
- #243MS**-Mini Small
- #243MM**-Mini Medium
- #243ML**-Mini Large
- #243P**-Pony



#243 ECONOMY 3/4" NYLON ADJUSTABLE HALTER

- With an adjustable nose piece
- Brass plated hardware
- Black, Blue, Burgundy, Green and Red
- #243MSA**-Mini Small
- #243MMA**-Mini Medium
- #243ML A**-Mini Large
- #243PA**-Pony



#243 ECONOMY 1" NYLON HALTER

- Brass plated hardware
- Black, Blue, Burgundy, Green and Red
- #243W**-Weanling (400-600 lbs)
- #243C**-Cob (600-900 lbs)
- #243H**-Horse (800-1200 lbs)
- #243HL**-Horse Large (1300-1700 lbs)
- #243D**-Draft (1600-2200 lbs)



#244 ECONOMY 6-RING 1" NYLON HALTER

- Brass plated hardware
- Black, Blue, Burgundy, Green and Red
- #244C**-Cob (600-900 lbs)
- #244H**-Horse (800-1200 lbs)
- #244HL**-Horse Large (1300-1700 lbs)



#252 1" NYLON 6-RING HALTER

- All stainless steel hardware
- Black, Blue, Burgundy, Green and Red
- #252H**-Horse (800-1200 lbs)
- #252HL**-Horse Large (1300-1700 lbs)



#253 PREMIUM 1" NYLON

- Brass plated hardware
- Black, Blue, Burgundy, Green and Red
- #253C**-Cob (600-900 lbs)
- #253H**-Horse (800-1200 lbs)
- #253HL**-Horse Large (1300-1700 lbs)



#2536 PREMIUM 6-RING 1" NYLON HALTER

- Brass plated hardware
- Black, Blue, Burgundy, Green and Red
- #2536C**-Cob (600-900 lbs)
- #2536H**-Horse (800-1200 lbs)
- #2536HL**-Horse Large (1300-1700 lbs)
- #2536D**-Draft (1600-2200 lbs)



#253R PREMIUM 1" NYLON W/OVERLAY

- Brass plated hardware.
- Black, Blue, Burgundy, Green and Red.
- #253RC**-Cob (600-900 lbs)
- #253RH**-Horse Large (800-1200 lbs)
- #253RHL**-Horse Large (1300-1700 lbs)

HALTERS

42

NEW



#258 PADDED NYLON HALTER

- Neoprene padding on crown & nose
- With an adjustable nose
- Brass plated hardware
- Black with Red, Blue, Green, Purple, Pink, Brown or Beige stripe
- #258C COB** 600-900 LB
- #258H HORSE** 800-1200 LB
- #258HL HORSE LARGE** 1300-1700 LB

MOST POPULAR DRAFT HALTER



1 1/4" NYLON DRAFT HALTER

- With brass plated hardware & SS snap
- Black, Blue, Green and Red, Burgundy
- #32ME** 1300-1700 LB
- #32LE** 1600-2200 LB
- #32XLE** 2200-2500 LB



1 1/4" NYLON DRAFT HALTER

- With White ribbon overlay
- With brass plated hardware & SS snap
- Black, Blue, Green and Red, Burgundy
- #32EWM** 1300-1700 LB
- #32EWL** 1600-2200 LB
- #32EWXL** 2200-2500 LB



1 1/4" NYLON DRAFT HALTER

- With patterned ribbon overlay
- With brass plated hardware & SS snap
- Black, Blue, Green, Red, Burgundy
- #32ERM** 1300-1700 LB
- #32ERL** 1600-2200 LB
- #32ERXL** 2200-2500 LB

NEW



252BH 1" Biothane Halter

- Can be made on order.
- All SS Hardware
- Nose top & Crown lined with Beta. Colors available.



1 1/4" NYLON DRAFT HALTER

- With SS Hardware
- Black, Blue, Green, Red, Burgundy
- #32MS** 1300-1700 LB
- #32LS** 1600-2200 LB
- #32XLS** 2200-2500 LB



#9027 RIDING BRIDLES

- Available in leather or beta
- Draft, horse, pony and mini sizes
- Come complete with reins
- Black or Brown

HALTERS



#240 BLACK LEATHER DRAFT HALTER
 • 1 1/4" 2 Ply Black Leather Halter
 • With Stainless Hardware
 • 1600-2200 LB



#242 TAN LEATHER DRAFT HALTER
 • 1 1/4" 2 Ply Tan Leather Halter
 • With Brass Hardware
 • 1600-2200 LB



#245 LEATHER HORSE HALTER
 • 1" 2 Ply Quality Leather Halter
 • Black with SS Hardware or Brown with Brass Hardware
 • 800-1400 lb.



ECONOMY LEATHER HALTER
 • 1" Single ply leather halter
 • Riveted at stress points
 • BP Hardware. Black or Tan
#251-T 800-1100 LB
#241-T 1600-2200 LB



#32LHD HEAVY DUTY 1 3/4" NYLON DRAFT HALTER
 • Extra heavy duty and durable
 • With Stainless Steel Hardware
 • Black Only. 1600-2200 LB
#32LD112
 Also available in 1 1/2" wide

#245BR Non Adjustable Nose
#245BR-A Adjustable Nose
#254BK Non Adjustable Nose
#245BK-A Adjustable Nose



#1750 LEATHER BIT STRAPS
 • 1" Leather strap
 • Comes in black or Brown
 • With stainless steel or brass hardware



#1753 HALTER BIT STRAPS
 • 1" Nylon strap with slide loop to fasten onto ring and a snap to fasten onto bit
 • Black, Blue, Burgundy, Green or Red
 • Stainless Steel or Brass Hardware



HEAD HALTER W/CHEEK STRAPS
 • A full around nose band
 • With cheek straps
 • Dees on nose band
#120-211 Leather
#117-211 Biothane
#417-211 Granite



HEAD HALTER W/HEAD STRAP
 • A full around nose band
 • With a strap over the head
 • Dees on nose band
#120-210 Leather
#117-210 Biothane
#417-210 Granite

LEADS / LUNGE LINES

#34L NYLON LEAD SHANK

- 1" x 95" double ply quality nylon lead
- Heavy 20" Brass Plated chain
- With Hand Loop
- Standard colours Black, Blue, Burgundy, Green or Red



#38 HALTER STEM

- 1" x 5' single ply nylon
- Comes with assorted snaps
- Stocked in black only



#37LC NYLON LUNGE LINE

- 1" x 30' nylon
- 20" Brass plated chain
- Standard colours Black, Blue, Burgundy, Green or Red



#39-CH CHAIN HALTER STEM

- 3/16" x 42" Zinc Plated chain
- With heavy snap



#37L NYLON LUNGE LINE

- 1" x 30' nylon
- Snap sewn in
- Standard colours Black, Blue, Burgundy, Green or Red



#418 NYLON NECK STRAP

- 1" x 11' Nylon neck tie strap
- Adjustable neck strap
- Black, Blue, Burgundy, Green and Red
- Heavy Duty Stainless Snap



Feel free to contact us with any special order halters and leads you would like done. Can be made from nylon, or biothane with lots of hardware options.

#432 NECK ROPE

- 1/2" x 11' Soft polyester braided rope
- Solid brass snap and an adjustable thimble
- Is horse chew resistant
- Black, Blue, Burgundy, Hunter Green and Navy Blue



<p>LEATHER LEADS</p> <ul style="list-style-type: none"> • Made with quality leather • Neatly creased and edged #41BKC Black leather with NP chain #41BRB Brown leather with BP chain #41WC White leather with NP chain 	<p>#36-34B COTTON LEAD ROPES</p> <ul style="list-style-type: none"> • 3/4" x 10' with bull snaps • Black, Blue, Brown, Green, Hunter Green, Navy Blue, Purple, Red, Teal, White and Wine 
<p>#420 NECK ROPE</p> <ul style="list-style-type: none"> • 1/2" x 12" twisted polypropylene rope • SS snap and ring • Black, Blue, Burgundy, Green and Red with a White tracer 	<p>#36-34 COTTON LEAD ROPES</p> <ul style="list-style-type: none"> • 3/4" x 10' with bolt snap • Black, Blue, Brown, Green, Hunter Green, Navy Blue, Purple, Red, Teal, White and Wine 
<p>#4202 POLY LEAD ROPES WITH CHAIN</p> <ul style="list-style-type: none"> • 5/8" x 8' Poly braided rope leads • With 20" nickel plated chain • Soft and durable • Black, Blue, Burgundy, Hunter Green, Navy Blue, Purple and Red 	<p>#40-58 POLY LEAD ROPES</p> <ul style="list-style-type: none"> • 5/8" x 8' Poly braided rope leads • With bull snaps • Soft and durable • Black, Blue, Burgundy, Hunter Green, Navy Blue, Purple and Red 

MINI / PONY LEADS

 <p>#36-12 MINI COTTON LEAD ROPES</p> <ul style="list-style-type: none"> • 1/2" x 6 1/2' Cotton lead rope • With NP bolt snap • Just perfect for your mini or pony • Blue/Green, Brown/White, Blue/White, Green/White and Red/White 	 <p>#40-12 MINI POLY LEAD ROPES</p> <ul style="list-style-type: none"> • 1/2" x 7' Poly braided lead ropes • With brass bolt snap • Soft and durable • Black, Blue, Hunter Green, Purple and Red 	 <p>#34M MINI/PONY NYLON LEAD SHANK</p> <ul style="list-style-type: none"> • Double ply 3/4" x 53" nylon lead • Comes with a 017 snap • Standard colours Black, Blue, Burgundy, Green or Red
---	---	---

PET SUPPLIES

Following are a few common pet products that we stock. We make many custom collars and leads, let us quote on any pets products you might need!

46

 <p>#261C ADJUSTABLE DOG COLLARS Adjustable nylon collar sizes : • 5/8" x 10"-14" • 3/4" x 14" - 18" • 1" x 18" - 26" • Black, Blue, Green, Orange, Purple and Red</p>	 <p>#262C NYLON DOG COLLARS • 3/4" Double ply collars • 14", 16" or 18" • Black, Blue, Green, Orange, Purple and Red #263C NYLON DOG COLLARS • 1" double ply collars • 20", 22, 24" or 26" • Black, Blue, Green, Orange, Purple and Red</p>	 <p>#265L NYLON DOG LEADS • 1" Nylon dog lead with swivel snap sewn in • Has a loop hand hold • 20", 48" and 72" • Black, Blue, Green, Orange, Purple and Red #264L NYLON DOG LEADS • 3/4" Nylon dog lead with swivel snap sewn in • Has a loop hand hold • 48" and 72" • Black, Blue, Green, Orange, Purple and Red</p>
 <p>#2259 LEATHER LEADS • Made with quality 1" tan coloured leather • NP snap and hand hold loop sewn in • 48" or 72"</p>	 <p>#2250 LEATHER DOG COLLARS • Made with quality tan coloured leather • NP Hardware • 18", 20", 22" 24" and 26"</p>	
<p>NEW BETA DOG COLLAR & LEADS • Made with Beta® from BioThane®. A nylon covered with a vinyl coating that is soft and has a leather look appearance. • Will not soak up sweat or water. • Easy to clean and maintain. • Manufactured in our facility's and made to last. • Many colors available</p>	 <p>#2230 5/8" BETA DOG COLLAR • Size 12", 14" & 16". #2231 3/4" BETA DOG COLLAR • Size 14", 16" & 18". #2232 1" BETA DOG COLLAR • Size 16", 18", 20", 22", 24" and 26".</p>	 <p>#2238 1" HUNTING COLLAR • Sizes 18", 20", 22", 24" and 26".</p>
	<p>LEASHES #2241 5/8" BETA LEASH #2243 3/4" BETA LEASH • Sizes 48", 60" or 72". #2244 1" BETA LEASH • Size 21", 48", 60" or 72".</p>	

DAIRY SUPPLIES



LEATHER DAIRY SHOW HALTERS

- America's most popular show halter
- Has an adjustable crown
- Rolled nose and cheek straps
- Black or Brown leather
- With a 6' matching lead
- #900** Cow Size
- #901** Heifer Size
- #902** Calf Size



#911 LEATHER SHOW HALTER

- Just a plain show halter with matching lead
- Bull, Cow or Calf Size



NYLON CATTLE HALTER

- 1" 2 ply nylon
- Black with BP hardware
- #286B** Bull Size
- #286XL** Large Cow Size
- #286C** Cow Size
- #286M** Heifer Size
- #286S** Calf Size



#266CT COW NECK STRAP

- 1 1/2" 2 ply nylon neck tie
- With tongue buckle and dee
- 36", 39", 44" and 48"
- Black only



#280CT COW NECK STRAP

- 1 3/4" Single ply nylon neck strap
- Adjustable web slide
- Black only



#283CT CALF NECK STRAP

- 1" Single ply nylon neck strap
- Adjustable web slide
- Black only



#4220 CATTLE ROPE HALTER

- Fully adjustable rope halter
- A must have for every farmer or vet
- Nylon nose piece
- Black, Blue, Pink or Red with White Tracer

#4221 CALF ROPE HALTER

- Same as above but smaller
- Black, Blue, Pink or Red



#426DS SISAL CATTLE HALTER

- Sisal rope cattle halter
- Fully adjustable rope halter
- A must have for every farmer or vet
- Leather nose piece

NEW



#4222 LEATHER NOSEBAND

- To help prevent chafing and hair loss on the rope halter.
- Soft leather with Velcro closures.



#4223 NEOPRENE NOSE COVER

- To help prevent chafing and hair loss on the rope halter.
- Neoprene with Cordura outer shell.
- Sold in pairs.

FARRIERS SUPPLIES



#6024 HORSE SHOEING STOCKS

Wooden horse shoeing stocks. Is 90% assembled on base for easy transport. May also be picked up at shop assembled.

- All items are pre cut & marked
- All hardware and straps are included
- Skid size is 43" x 89" x 15"
- Weight 1,000 lbs.
- Made in Canada
- Made with white oak

#6024-DIY Do-It-Yourself Kit

All the hardware if you cut the wood!

#6024-OS Oversize Stocks

Inside Dimensions: 34" wide x 66" long x 7" high



#6025 FARRIER APRON

These aprons are made with the full time farrier in mind.

- Made with cordura material
- Has leather knee patches and two leather knife pockets
- Adjustable waist and leg straps
- Available in Black, Blue or Green



#6028M-12 MUSTAD SHOE PULLER

These pull offs have precision teeth on the outside to make it easy to spread and widen shoes. Overall length is 12".



#6029 SIMONDS RED TANG RASP

This rasp offers proven superior performance under normal dry conditions. Will stay sharp longer. Overall length is 14".



#6028D-12 DIAMOND SHOE PULLER

These pull offs have exclusive pattern on the outside edges to spread or widen shoes. Can also be used for cutting nails. Overall length is 12".



#6030 SCREW ON FILE HANDLES

Screw on handles for the above files. Wood or plastic.



#6026M-15 MUSTAD HOOF NIPPER

Mustad nippers are precision machined and feature a hardened edge to provide the best trim. 15" Overall length.



#6033M-12 MUSTAD NAIL CLINCHER

This nail clincher is designed with an extra tooth for higher driven nails. Overall length is 12".



#6980 HOOF PICK

A wire hoof pick with a rubber coated handle. Comes in assorted colours.



#6026D-15 DIAMOND HOOF NIPPER

Professional quality precision manufactured from special alloy steel with button rivet. 15" Overall length.



#6033D-12 DIAMOND NAIL CLINCHER

This nail clincher works well for larger nails. Overall length 12".

#6018 FARRIERS TOOL BOX

A durable farrier's tool box made from puck board. Has file holders on each side. 3 nail compartments with 2 sliding covers on top. With swivel rolling wheels. Black only.

16 1/4" x 14 1/2" x 28"



FARRIERS SUPPLIES



#6983 DOUBLE EDGE HOOF KNIFE
This knife has a double blade that can be used for left or right hand. Has a wooden handle.



#6982 HOOF KNIFE
This hoof knife comes with a plastic handle and your choice of right or left hand.



#6984 LOOP BLADE HOOF KNIFE
This hoof knife has a loop blade so it can be used for left or right hand. Has a wooden handle.



#6981 DIAMOND HOOF KNIFE
A high quality hoof knife with wooden handle. Comes in right or left hand.



#6023 DIAMOND CLINCH BLOCK
Solid steel block for clinching and seating nails.



#6022 DIAMOND CLINCH CUTTER
An all purpose tool with one end designed for cutting and the other a pritchel. High quality forged steel with beveled edge on outside.



#6032 DIAMOND FARRIER HAMMER
This farrier hammer is forged with high quality steel and has a hardwood handle. Available in 10 oz. and 14 oz.



LEATHER SHOE PAD
A sole leather shoe pad that can be trimmed to the size you need. Two sizes to choose from.

#8045 Shaped 8 1/4 x 7 3/4
#8045L 10" Square



#4029 PULLING SHOES

Diamond draft pulling shoes. These shoes have been heated, turned and rounded with plates welded on the toes. Front plates are tilted. Sold in pairs.

#4029-6 Fronts and Backs
#4029-7 Fronts and Backs
#4029-8 Fronts and Backs



#4060 Anvil Brand Pulling Blanks
These shoes are forged, punched and creased for easy application. Heels can be turned up or cut off. Two sizes to choose from.

Constructed from 1/2" x 1" Bar
#4060-6 9 1/2" x 6 1/2"
#4060-8 9 7/8" x 1 1/8"



KERCHAERT DRAFT SHOES
These shoes are toe clipped at the front and are punched for regular head nails. Available in four sizes and fronts and backs.

#4025 #5 6 3/4" x 6 7/8" x 3/8"
#4026 #6 7" x 7 1/8" x 3/8"
#4027 #7 7 1/4" x 7 3/8" x 3/8"
#4028 #8 7 3/4" x 7 3/4" x 3/8"



#4030 PRO DRIVE IN STUDS
These studs need a 3/16" drill hole. Are sold individually or in bags of 50.



#4031 PRO SCREW IN STUDS
These studs take a 5/16" drill and a 3/8" tap. Are sold individually or in bags of 50.



#8050 CAPEWELL HORSESHOE NAILS
These nails are regular head nails. Come in size 5-12. Sizes 5-7 have 250 nails per box and 8-12 have 100 nails per box.



#8055 MUSTAD HORSESHOE NAILS
These nails are regular head nails. Come in size 5-12. Sizes 5-7 have 250 nails per box and 8-12 have 100 nails per box.

HOOF BOOTS, PADS, ETC.



DAVIS POULTICE BOOT
Designed for applying poultices and soaking with other hoof dressings when injury or infection affects the hoof. Sold by each.
#687-L 7"W x 7 3/4"L
#687-XL 7 3/4"W x 8 1/2"L
#687-D 9 1/2"W x 9 1/2"L



BELL BOOTS
Rubber bell boots with Velcro closures. Sold in pairs.
#683-M
#683-L
#683-XL



ANDLE PADS
Made from quality harness leather with a neoprene lining. Fastens with 2" hook and loop. Sold in pairs only.
#689H-Horse
#689D-Draft



#686 Knee Pads
• Durable pads with strap & buckles
Sizes:
Small, Medium, Large



#8058 DRAFT HOCK BOOTS
Neoprene material perfectly shaped to form around the hock with Velcro fasteners. Black only. Sold in pairs.

#10432 Tendon and Ankle Pads
Lined with neoprene with Velcro fasteners. Sold in pairs.



#8059 DRAFT SHIPPING BOOTS
A draft size shipping boot made from cordura with a fake fur lining and Velcro Fasteners. Available in Black, Blue, Green and Red. Sold in sets of 4.



LEATHER SPATS
Used to prevent damage to the feather on a Clydesdale & Shire. Made from bridle leather with a buckle closer. Sold in pairs.
#8057-S Small 11 3/4"W x 5 1/4"H
#8057-M Medium 14 1/4"W x 7"H
#8057-L Large 16 1/4"W x 8 1/2"H

SOFT SPATS
These are very soft and pliable made from grey apron leather.



#8056-S Small 11 3/4"W x 5 1/4"H
#8056-M Medium 14 1/4"W x 7"H
#8056-L Large 16 1/4"W x 8 1/2"H

HOOF CARE

ABSORBINE HOOFLIX
Hooflex is America's #1 best selling hoof conditioner and has been on the market for 85 years. For relief and prevention of dry cracked hoofs. Also promotes healthy hoof growth.
#7028 450 ml Liquid w/applicator



ABSORBINE SUPERSHINE
Gives your horse's hooves a magnificent mirror-like finish and dries in less then 60 seconds. Comes with a handy dabber fastened to lid.
#7046 Clear 240 ml.
#7047 Black 240 ml.



HOOF CARE



#7030 VENICE TURPENTINE
A highly effective disinfectant and anti-bacterial agent that acts as a counter-irritant to promote circulation and new hoof growth. Also acts as a hoof toughener and helps eliminate pain during strenuous exercise. 473 ml.



#7083 PINETAR
A natural antiseptic that retains moisture in the hoof thereby making the hoof elastic and flexible while promoting new growth. Also an old world remedy for coughs and congestion. 900 ml.



#7500 Yoder's Hoof Builder

- Excellent for cracked hooves and quarter cracks
- Quart size comes with a brush
- Gallon size available



FIEBING'S HOOF DRESSING
A liquid hoof dressing for treating corns, quarter cracks, split hooves and brittleness. If used regularly it helps maintain healthy feet.

#7032 946 ml
#7033 Gallon
#7034 946 ml w/applicator



#7027 KOPPER KARE
Is used for the treatment of thrush, hoof punctures, and cracked hooves in horses. 475 ml.



NO THRUSH
First ever dry formula to treat equine thrush treatment. Natural, fast, easy, clean. Apply in seconds. Treat thrush in 4-6 days.
#7075-2 70.9gm
#7075-5 155.9gm



#7026 CORNUCRESCINE
Promotes and accelerates healthy hoof growth and aids re-structuring. Maintains optimum hoof condition. Economical application also aids re-growth of hair. 450 grams.



#7067 MUSTAD THRUSH BUSTER
For treatment and preventing thrush in horses. May be used on sole and frog prior to shoeing with pads and silicone. One single application is usually sufficient for treatment. 60 ml.



HOOF HEAL
Super penetrating conditioner from Cut-Heal. Achieves long-lasting moisture balance. Anti-bacterial and anti-fungal to help prevent infection. Aids in preventing and eliminating thrush. Keeps coronary band, heel, sole and frog healthy.
#7023-P 454ml
#7023-Q 909ml

DENTAL CARE



#6996 MOUTH SPECULUM

- Heavy duty nylon straps
- Tooth plates for upper and lower incisors
- Stainless steel



#6998 CURVED TOOTH RASP

- Files upper, lower and molar teeth
- 23" overall length
- Rasp is 4 1/2" x 1 1/2"



#6997 DENTAL FLOAT

- Comes with curved or straight file
- Files can be replaced

WOUND CARE

#7025 PF Wonder Salve

- A new wound cream with highly positive feedback!
- 2 oz jar.



#7041 BAG BALM

Helps soothe cuts, scratches, skin irritations, and abrasions. Bag Balm has been around for over 100 years. Goes on fast and stays on. 10 oz jar.



#7084 IODINE SPRAY

An aid in the treatment and control of bacterial infections of superficial wounds such as navel stumps, dockings and castrations. Also for disinfection of skin areas prior to injections or surgical procedures. 500 ml sprayer.



GALL SALVE

This product is a must for every working horse! Quickly relieves collar and saddle galls whether the horse is idle or at work. Quick relief for galled shoulders, necks, backs, scratches, cuts, mud scalds, hobble chafes and minor wounds and sores. **#7042** 5 oz. **#7045** 14 oz.



#7060 WONDER DUST

Wonder Dust is dressing powder and blood coagulant for use on certain types of wounds, cuts and abrasions. Specially formulated for use on horses. A caustic and drying agent for slow healing lesions and excessive granulated tissue (proud flesh). Plus, it contains a deodorant to remove objectionable odours from foul or infected wounds. 4 oz. bottle.



#7058 CUT & HEAL WOUND CARE

- Very effective and Promotes Healing
- Helps Prevent scarring!
- 16oz Spray Bottle (liquid)



#7059 BLU-KOTE WOUND SPRAY

Treatment of surface wounds, cuts, galls, hoof, foot and pad sores, fungicidal wound dressing and healing aid, Treat ringworm lesions. Dries up pox-like lesions. 142 gm



#7089 Corona Multi-Purpose Ointment

A very good special formula first aid protection for minor cuts, bruises and burns. An aloe vera based ointment. A must for every barn. 236 gm jar.



#7300 Banixx Wound Care Cream

Soothing relief for fungus, wounds, hot spots, rain rot, ringworm, scratches and skin yeast infections. Enhanced with Marine Collagen 8-oz bottle



#7044 SEALTEX LATEX BANDAGE

SEALTEX is the only bandage that is completely unaffected by water. It is made without a weave or mesh so it will not become clogged with mud and it absorbs no water. It can also be used for bit wrap and the nosepiece on your hackmore.



7076 HEALZALL WOUND SPRAY

A unique spray with pine oil, soap, and alcohol with very good result for open wounds, proud flesh and scratches. 16oz spray bottle.



#7086 MTG PLUS

Same formula as the original but with an added herbal scent. Works great on fungus, rain rot, girth itch, scratches, sweet itch, tail rubbing, dry skin, bug bites and promotes many & tail growth while conditioning and detangling. 946ml



#7043 TRUE FLEX WRAP

Pro adhesive bond. Reliable in wet conditions. Tears evenly and consistently. Comes in assorted colours. 4" x 5 yard rolls.



#70-7200 PROUD FLESH DUST

Proud Flesh Dust is a specially formulated counter-irritant, astringent, and antiseptic powder. 200 gm.



#7070 BLUE LOTION

A quick drying antiseptic wound & gall lotion. Use for the treatment of wounds, minor cuts and abrasions, harness galls and saddle sores. Comes with a dauber in the bottle. 4 oz Bottle.



SUPPLEMENTS AND MINERALS
~ BLACK'S FEED SUPPLEMENTS ~

PREMIUM SUPPLEMENT

This is a special blend of selected vitamins and minerals formulated to elevate your horse to full potential. Black's vitamin and minerals supplements contribute to improved hair and coat condition. Improved hoof quality, increased feed efficiency. Reduced grain intake. Weight gain and improved vigor, stamina and growth.



- #7036-10 10 lb Pail
- #7036-25 25 lb Pail
- #7036-44 44 lb Bag

**7128-HLB
Nieuwland Hi-Bio
Mineral**

NEW



Formerly known as Stayner Mineral

A very good choice and a good price for an all-around free choice mineral. High in Biotin for better hooves. Proven to help with scratches. 20kg Bag

SURELIFE MARE & FOAL SUPPLEMENT



For the Mare - In the last trimester of her pregnancy, your brood mare needs twice the calcium and phosphorus in her diet to produce that strong thrifty foal you are looking forward to. SURELIFE meets your broodmare's higher nutritional needs.

For the Foal - Vitamin A is not passed through the placenta to your foal. This deficiency jeopardizes the immune system, increasing the potential for your foal contracting contagious respiratory and diarrheal illnesses. By maximizing Vitamin A and other vital nutrients in your mare's milk, SURELIFE helps replenish your foal's nutritional levels getting them off to a thrifty, healthy start.

- #7035-10 10 lb Pail
- #7035-25 25 lb Pail
- #7035-44 44 lb Bag

BIO-PLUS SUPPLEMENT

You get two products in one with Bioplus. A biotin supplement proven to aid in hoof repair and maintenance, plus a complete and balanced mineral, vitamin and amino acid supplement a tremendous value!



- #7037-10 10 lb Pail
- #7037-25 25 lb Pail
- #7037-44 44 lb Bag

~ PENNWOODS PRODUCTS ~

**2X BLUE LABEL
(Double Strength)**

Blue Label 2X (Double Strength) is a blend of concentrated ingredients formulated to nutritionally balance and enhance your horse's diet. New lower amount required per feeding will improve palatability.



- #7120-25 25 lb Pail
- #7120-4 4 lb Pail

**2X BIO PLUS 60
(Double Strength)**

Bio Plus 60 2X (Double Strength) is a blend of concentrated ingredients with optimum levels of biotin, and formulated to provide nutritional balance to your horse's diet with improved hoof growth and quality. New lower amount required per feeding will improve palatability.



- #7121-25 25 lb Pail
- #7121-4 4 lb Pail

BODY BUILDER 4000

Pennwoods Body Builder 4000 is a 40% fat, 26% protein nutritional supplement designed to promote weight gain and act as a body conditioner.



- #7100-11 11 lb Pail
- #7100 25 lb Pail
- #7100-B 50 lb Bag

NU-LIFE MARE & FOAL

Supreme Nu-Life Mare & Foal is Pennwoods Equine Supreme's formula created for the optimum health of the brood mare and her foal.



- #7105 25 lb Pail
- #7105-B 50 lb Bag

NXT-GENERATION

The future in sound nutrition for today's horse. NXT-Generation is a completely fortified "cool energy"® nutritional equine supplement. Is a mixture of Nu-Life & Body Builder 4000.



- #7103 25 lb Pail
- #7103-B 50 lb Bag

BIO-GENERATION

BIO-Generation includes high levels of biotin to improve hoof quality. It is fortified "cool energy"® nutritional equine supplement of choice available to today's horse enthusiast. Is the same as NXT-Generation with added biotin.



- #7104 25 lb Pail
- #7104-B 50 lb Bag

2-12 FOAL SUPPLEMENT

2 to 12 is a 32% protein, 12% fat supplement that is specifically formulated for foals age 2 months to 12 months. Along with oats or grain mix, it provides high levels of milk protein, vitamin E, other vitamins, other minerals and the optimum levels of organic selenium.



- #7106 25 lb Pail
- #7106-B 50 lb Bag

SUPPLEMENTS AND MINERALS
~ OMEGA ALPHA EQUINE PRODUCTS ~

Natural herbal supplements for your horse. These are some of their products we are currently carrying. Please call if you do not see what you are looking for and we'll get it for you.

#7111 GLUCOSAMINE POWDER
This works well for sore joints. Available in 1 kg jar.



#7113 KIDNEY FLUSH
Cleanses the liver, promotes liver regeneration and provides anti-oxidants to the liver tissue for support. It can also improve appetite. Available in 1 L & 4 L jugs.



#7110 ANTI FLAM
AntiFlam is most commonly used to alleviate pains and body aches caused by inflammation. Very effective in treating Navicular, Laminitis and Founder. Available in 1 L & 4 L jugs.



#7112 HEALTHY HORSE
A combination of Hemex(Blood Builder), Lung Flush (Expectorant), Liver Flush (Liver Support) and Immune Boost (Immune System Enhancer) used extensively with performance horses.
Overview: Hemex Component
Used for treating cases of low red blood cell counts or when higher than normal cell count may be beneficial for High Performance Horses. The only blood builder that triggers the body to release blood cells from the bone marrow.
Overview: Lung Flush Component
Cleanses the lungs by increasing blood flow to the lungs and acting as an expectorant. It also provides antioxidant support for the lung tissue.

Overview: Liver Flush Component
Cleanses the liver, promotes liver regeneration and provides anti-oxidants to the liver tissue for support. It can also improve hair, coat, energy levels and appetite.
Overview: Immune Plus Component
Enhances immune system function to combat pathogens. It does this by activating a number of immune system pathways with a synergistic combination of ingredients. Is available in 4 L only.

#7114 RESPI-FREE LUNG FORMULA
Total Lung Formula a first line treatment for breathing problems. Cough Suppressant, Bronchodilator, Expectorant, Anti-inflammatory. Is a 3-in-1 Formula containing Airwaves, Lung Flush and Herba Coff.



#7115 PARASITE FORMULA
PARA-X is used as a general parasite cleanser. Kills and paralyzes tapeworms, pinworms, hookworms, roundworms and others. Available in 1 L & 4 L jugs.



EBERGLO SUPPLEMENT

Eberglo is a mix of probiotics, prebiotics, natural plant enzymes, vitamins and premium processed minerals. Eberglo provides a source of critical nutrients that have become depleted in soils, crops and feeds. A healthy digestive system creates a healthy horse. This results in less feed intake.

#7134-Q Quart
#7134-G Gallon



Nutra-Glo Supplement

Nutra-Glo is a brand of probiotic products for livestock. All Nutra-Glo probiotic products are obtained through the multi stage fermentation process of multiple, proprietary strains of lactic acid bacteria. The products contain a complex mixture of fermentation metabolites including proteins and protein hydrolyzates, peptides and amino acids, organics acids, and carbohydrates combined with chelated/complexed trace minerals and bio-available vitamins, The products do not contain live microorganisms. The product is naturally derived through a proprietary fermentation process, and contains chelated food-grade vitamins and minerals, organic chelating agents, and microbial metabolites.

#7131-P Pint **#7131-Q Quart**
#7131-G Gallon



LINIMENTS

#7063 BALL SOLUTION

Original Ball Solution is an excellent liniment for the relief of muscle soreness, curbs, splints, ringbone, cracked heel, bowed tendons and big knees due to overexertion. Contains 6% iodine. Apply twice a day for two days, then once daily as needed. 473 ml.



ABSORBINE LINIMENT

The effective conditioner for relief and prevention of lameness which can be benefited by external application. Helps reduce swelling. Tones up muscles. Acts as bracer and tightener. Treats minor cuts-abrasions and fungus infections. Horses can be worked during treatment. Made from a formula of herbs and oils.



#7080 475 ml #7081 950 ml
#7082 3.8 ml

#70-7252 Bigeloil Liniment

-Reduces soreness from fatigue or strain
-Antiseptic and anti-bacterial properties
-Works as a re-freshing brace or body wash for horses after strenuous muscular activity



#7065 MCTARNAHNS B-R LINIMENT

A counter-irritant rubefacient with Camphor for horses to be used as an aid in the temporary relief of minor soreness and stiffness caused by overexertion. 237 ml.



#70-7250 LEG & MUSCLE RUB

This old style special veterinary liniment has been a favourite for years. Stimulates circulation and relieves muscular soreness and stiffness due to overexertion, strains, swelling, windpuff and minor injuries. 475 ml.



~ FARRIERS FORMULA ~

#7050-11 FARRIER'S FORMULA

Farrier's Formula is a balanced nutritional supplement for the dermal tissues (skin, hair and feet). Builds a strong healthy hoof and enhances coat and hair. Promotes hoof growth for cases of brittle, cracked and flaking horn. Ideal for horses that often lose shoes due to brittle/flaking feet. 11 lb Pail



~ RESPIRATORY AIDS ~

ZEV LIQUID

Zev is an effective remedy for several types of respiratory problems. It may be used for the treatment of stable coughs and upper respiratory ailments, broken wind or heaves and nasal congestion. Aids in the horse's digestive system and helps increase the nutritional value of every meal. Gives a brighter coat, clearer eyes and improved breathing. #7000-2 2 L Jug #7000-4 4 L Jug



#7050D-11 DOUBLE STRENGTH FARRIER'S FORMULA

The nutrients in Farrier's Formula® Double Strength, important for a healthy hoof, are provided at twice the concentration compared to original Farrier's Formula® with the taste that horses love! This is an 11 lb refill bag.



YODER'S HORSE POWDER

Conditioner plus astringent. Is your horse troubled with heaves, coughs, runny nose or coated nostrils after use? Then this product is for you with its all natural ingredients. #7006-1 1 lb Pail #7006-5 5 lb Pail



#7001-Q WIND AID

Wind-Aid offers temporary relief of equine bronchial congestion, minor throat irritation and wind problems. 946 ml.



FLY CONTROL

#7056 BRONCO FLY SPRAY
Water based fly spray with citronella scent. Kills and repels six fly species, ticks, biting midges and mosquitoes.
#7056-1 950 ml W/Sprayer
#7056 3.78L Jug.



ABSORBINE ULTRA SHIELDEX
Ultra Shield will repel flies, mosquitoes and gnats up to 5 days. Is a water based formula and scented with citronella.



Also contains sunscreens, coat conditioners including aloe and lanolin to help groom as well as protect from insects.
#7048 950 ml W/Sprayer
#7048-4 3.78L jug

FLY NETS

Long cords slide back and forth when horses move to keep away flies. Attaches to harness or halter with cords.



- #9050** Face Fly Net
- #9062** Horse Size Body Net
- #9064** Draft Size Body Net

#7055 WIPE
Liquid wipe on formula repels horse flies, house flies, stable flies, deer flies, gnats and mosquitoes for a full 24 hours and kills them on contact. Helps in the removal of dirt and dandruff and adds shine to the coat. 950 ml jug.



#7052 KONK FOR HORSES
A quiet pressurized spray that repels and kills flies, mosquitoes and gnats on horses. 275 gm can.



#9055 EQUESTAR FLY MASK

Extremely durable, the soft nylon micro mesh is plastic coated and helps to block out damaging UV rays.

- Soft nylon mesh ears keep annoying insects out of your horse's ears.
- Eye darts keep the mesh away from their eyes
- Grey mesh with Black trim
- Available in Draft, Warmblood, Horse, Cob, Pony and Mini



70-4010
Doktor Doom Horse Spray Fly Killer 500g



Protects horses from attacks of Black flies, face flies, house flies, horn flies, horse flies, and mosquitos.

7049 EZall Green Fly Spray
Safely and effectively defends animals against flies and insects. Easy application. All-natural formula. Environmentally friendly and safe for people and animals.



Mr. Sticky Fly Tape System

Sticky Roll™ effectively catches, controls and eliminates flies because it's based on their natural habits. Flies follow the warm updrafts in rooms and barns, seeking a resting place near the ceiling. They become entrapped in Sticky Roll, then become an irresistible attractant to other flies. No baits, toxins, or pheromones are necessary. Soon the tape is black with dead flies. When a length of tape is full, crank it up, flies and all onto the disposable take-up reel. Fresh tape is rolled out at the same time, ready to grab more flies. Sticky Roll™ reel-to-reel Fly Tape System is available in several sizes, ranging from the 8 foot Quick Strip to the Deluxe Kit with 600 or 1000 feet of tape, and features attractive, informative packaging.



#70-4006 LEATHER FLY SWATTER
• This fly swatter will outlast any others



#70-4000 Mr Sticky Roll Mini Kit



#70-4001 Mr Sticky Mini Kit Refill



#70-4002 Sticky Roll Fly Tape Deluxe Kit



#70-4003 Sticky Roll Fly Tape 1000FT Refill



#7040 Mr Sticky Fly Stickers

#70-4004 Milk Jugg Trap
Turn ordinary plastic jugs into effective, insecticide-free fly traps and catch over 35,000 flies economically. Includes attractant flies can't resist. Just add water and attractant and pop on the top. Set on the ground or hang up. Reusable.



DEWORMERS



#7011 POWERMECTIN PASTE
Powermectin is an ivermectin oral paste for horses, for the treatment of parasitic infections due to internal parasites, including bots. 1.87%. 6.42g



70-4020 Quest Gel Dewormer
Quest Gel® Moxidectin, provides horse owners worldwide with effective control against a broad spectrum of internal parasites, including bots.



#7013 SAFE-GUARD PASTE
Apple-cinnamon flavour added makes this paste wormer highly palatable. Controls large stongyles, small stongyles, pinworms, ascarids and 4th stage larvae of "strongyle vulgaris". One tube of 25 gm does 500 kg (1100 lbs).



#7015 QUEST PLUS GEL
A gel paste that melts in your horses mouth and will protect your horse for 84 days. This dewormer will treat large and small stongyles, ascarids, pinworms, hairworms, large mouthed stomach worms, stomach bots, integumentary microfilariae and tapeworms. One tube of 11.5 gm will treat 575 kg (1250 lbs).



#7004 EXODUS DEWORMER
For use in horses and ponies for the removal and control of mature infections of large and small strongyles, pinworms, and large roundworms. Contains 43.9% pyrantel pamoate. Apple flavoured. Dosage: A single oral dose of 3mg pyrantel base per lb of body weight. One syringe treats 1,200 lbs.



#7007 EQVALAN GOLD
For the treatment and control of intestinal roundworms, lungworms, tapeworms, bots and skin lesions caused by Habronema and Draschia spp (summer sores) and Onchocerca spp microfilaria (cutaneous onchocerciasis) in horses. Use one syringe for 600kg of body weight.



IVERMECTIN LIQUID DEWORMER
Ivermectin for horses is indicated for the treatment of large and small strongyles, intestinal threadworms, pinworms, ascarids, hairworms, large-mouth stomach worms, neck threadworms, bots. Can be top dressed directly onto horse's feed or squirted right into horse's mouth
#7002 Tube Size, One tube treats 750 kg.
#7002-120 120ml bottle, Syringe included



#7008 EQUIMAX
Is the only combination wormer ivermectin/praziquantel dewormer proven safe for ALL horses including foals 4 weeks or older, pregnant and lactating mares and breeding stallions. Single dose treats a broad range of equine parasites including bots and tapeworms. Apple flavor. One syringe will treat up to 1320 lbs.

GROOMING SUPPLIES



#6950 PLASTIC CURRY COMB
Molded plastic with an adjustable handle. Size: 7" x 3 1/4". Available in Black, Blue, Green, Hunter Green, Purple, Red, Wine and Yellow.
#6950-M MINI PLASTIC COMB
A child's version of the above curry comb. Size: 4 1/2" x 2 1/2". Assorted colours.

#6955 DANDY BRUSH
Wooden handle with medium nylon bristles. Size: 8 3/4" x 2 3/8" x 2 1/2". Available in Black, Blue, Green and Red.
#6955-M MINI DANDY BRUSH
A mini version of the above dandy brush. Perfect for a child to help brush the horses. Available in Blue and Pink.



#6951 Bot Knife
Specially designed to help scrape along the horse's legs to aid in the removal of bot eggs



#4812 Roto Brush
Attachment for your drill to clean your horse fast and easy!



#6970 SHED N' BLADE
Stainless Steel metal teeth on 1 side with a plastic handle. Will remove matted hair. Smooth side can be used for sweat scraping and water removal.



#6958 STAINLESS STEEL CURRY COMB
Reversible curry comb with plastic handle.

GROOMING SUPPLIES



#6971 FETLOCK SHEARS
Stainless steel with curved blades. Works great for trimming fetlocks.



#6960 ALUMINUM SWEAT SCRAPER
A light weight sweat scraper. Size: 15" x 1 3/8"



#6960-P PLASTIC SWEAT SCRAPER
Curved plastic sweat scraper. Size: 17 1/2" x 1 3/8" Assorted colours.



#6972 ALUMINUM MANE COMB
An aluminum mane comb with coarse teeth. Size: 4" x 2 1/4"

#6974 MANE & TAIL THINNING KNIFE
Perfect for keeping mane and tails perfectly groomed. Ideal for removing mats and tangles. Stainless Steel blades with a plastic handle.



#6969 RUBBER GROOMER
Long flexible fingers massage the body and legs. Tips are gently rounded for comfort. Made of flexible black rubber. Works great to loosen and remove old hair.



#6977 PLASTIC COMB
Lightweight durable mane & tail comb. Rounded teeth. Size: 9" long. Assorted colours.



#6978 THINNING KNIFE
Fold-away thinning comb quickly and effectively thins down thick manes. Stainless steel blade. Size: 6 3/4" when open.



#6975 BURR OUT
Works great to remove burrs and tangles from mane and tails. Stainless steel teeth with a rubber handle. A heavy duty mane comb.



#6985 GROOM CADDY
Here is a great plastic tote to carry your grooming supplies. Is slotted for hoof picks etc. Size: 15" x 9 3/4" x 4". Assorted colours.



#6956 DELUXE HOOF OIL BRUSH
Wooden handle with synthetic bristles. A great way to apply hoof oils. Size: 10 1/2" long.

#7090 ABSORBINE SUPERPOO SHAMPOO
A high sudsing and quick rinsing shampoo with conditioners. Removes dirt, dandruff, coat and fly sprays. 950 ml bottle.



ABSORBINE SHOW SHEEN
The #1 hair polish on the market. This unique formula coats each hair shaft to keep manes and tails tangle free and its conditioning action reduces fly-aways. It makes coats smooth and sleek, and repels dirt, dust and stains.
#7092 950 ml w/sprayer
#7092-G 3.8 L jug



MISCELLANEOUS

FEED SCOOPS
Galvanized feed scoops with handle.
#6060-2 2 Quart
#6060-4 4 Quart



#10545 One Man Twitch **NEW**
Requires only one man to operate. Made of Nickel Plates Steel.



#7078 CHEW STOP
Clear non-staining formula contains natural ingredients. Can be applied on all wood surfaces, indoor and out. Dries quickly and is not effected by moisture once it dries. Can be applied in wet weather. An economical way to put an end to chewing and cribbing. 950 ml bottle w/sprayer.



#6059 FEED CART
#199190 FEED BIN



#435 HORSE MUZZLE
Good Quality fine mesh muzzle with head band and throat latch.



#6990 HUMANE TWITCH
Releases calming endorphins to calm the horse in stressful situations. Measures 13 1/4" long.



#2530 WATER BOWL
Wide poly water bowl with 1/2" top feed.



#6989 ONE MAN ALUMINUM TWITCH
Requires only one man to operate. Rope and aluminum construction with double end snap.



#6993 MIRACLE COLLAR
Stops cribbing in seconds. All leather with stainless steel hardware. Large & medium.



#82P WATER BOWL
Poly water bowl with casting. Nylon frost plug protection. 3/4" water line entry top or bottom.



#6988 CHAIN TWITCH
Traditional, effective chain twitch with a finished wooden handle. Measures 17 1/2" long.



#6992 CRIBBING STRAP
Helps horses stop cribbing. Steel hardware with a nylon strap.



#S91 AUTOMATIC FLOAT BOWL
Powder coated steel bowl. Hinged cover for easy maintenance. 1/2" Line entry on either side of bowl.



ALUMINUM MEASUREMENT STICK
Polished aluminum measures in hands on 1 side and centimeters on the other. Will do up to 18 hands. Push button vertical beam has easy to read plumb vial for accuracy. Telescopic in centre for easy storage.
#3002 Draft Size
#3003 Mini Size



#3004 BAMBOO MEASURING CANE
Heavy Bamboo cane with a chrome plated tip that contains a measurer in inches, hands and centimeter. Solid brass level for accurate measurement. Maximum height 17.3 hands.



#3006 MEASUREMENT TAPE
Now made of wider unbreakable vinyl coated nylon. Will measure the height and weight in lbs and kgs of your horse. Maximum height 20 hands.



WHIPS

OVERSIZE FREIGHT

Because of oversized charges and additional handling charges from the courier companies, it is best to contact us for a quote on shipping whips.

#6075 BUGGY WHIPS

- Black braided whips with a fiberglass centre
- Rubber hand grip
- 8" drop
- Come in 50" 60" 66" 72" 78" and 88"
- 66" also available in Black/White, Blue/White, Green/White or Red/White



DRESSAGE WHIP

- A dressage whip for carriage driving.
- Black whip with white handle
 - 48", 60", 72"
 - Black or Red popper
- #6072** No Drop 8" Popper
#6073 24" Drop 8" Popper



#6078 BULL WHIP

- Hand braided latigo leather with a wooden swivel handle.
- 8ft length



#6077 ECONOMY WHIP

- Imported stock yard whip
- 60" Black only



#6099 LUNGE WHIPS

- Black braided whips with a fiberglass centre.
- Rubber hand grip.
- 66" only.



#6076 WHIP POPPER

- Replacement nylon popper is 12". Black or Red.



#1012 WHIP HOLDER

- A handy whip socket for on your cart, buggy or wagon to hold whip. Available in Brass, Chrome or polished stainless steel.



HOOKS & RACKS, HITCHING RINGS & DOOR LATCHES

CAST IRON HARNESS HOOKS

Perfect for hanging up your harness. High quality, extra clean castings. Black only.

- #6009 5" long
- #6010 8" long
- #6011 10" long
- #6012 12" long



BRASS HARNESS HOOKS

Solid brass harness hooks with a hand polished shiny finish. Works great for hall tress, coat racks and other decorative uses.

- #6014 4 1/2" long
- #6016 8 1/2" long



#412 BRIDLE HOOK

Metal bridle bracket. Black only.



#6013 TACK HOOK

Keeps tack tidy and organized. Features a four-pronged design with a red powder coat. Great to use when cleaning tack. Measures 12" high.



#414 HITCHING RING

ZP 2" ring with 4" bolt



#416 HITCHING RING

ZP 2" ring with a 4" screw eye.



HEAVY DUTY

#328F-P FANCY HITCHING RING

Heavy duty 2 1/2" ring on a 1 1/2" x 7" fancy plate with 3/8" pre drilled holes. Black powder coated.



#415 HITCHING RING

ZP 2" ring on a stamped plate.



#6017 COLLAR HOOK

Just the hook you need to hang up those collars. Black powder coated steel.



10 1/2" high x 9 1/2" wide.

HEAVY DUTY

#6080 BARN DOOR LATCH

- Heavy duty construction.
- Very popular for barn doors.



HEAVY DUTY #6084 EASY LATCH

- Ideal for sheds, barns and work shops.
- Plated finish.
- Is casted.
- Does doors from 1"-2 1/4" thick



HEAVY DUTY

#328-B HITCHING RING

Heavy duty 2 1/2" ring on a 1/2" x 12" threaded rod. Cut to desired length. Black powder coated.



HEAVY DUTY

#328-P HITCHING RING

Heavy duty 2 1/2" ring on a 3 1/2" x 3 1/2" plate with 3/8" pre drilled holes. Black powder coated.



#9045 HARNESS STANDS

- Works great to store harness on
- 57" long, 20" wide, 51" High
- Unassembled for shipping
- Can be wheeled to and from tack room
- Steel



HAY FEEDERS

3 SIZES TO SELECT FROM...

• Black Powder Coated Enamel • 1/2" Rods • 16 Gauge Back/Sides • 3 1/2" Rod Spacing



HAY/GRAIN COMBO FEEDERS HAVE SAFETY EDGES

SMALL SIZE 1 FLAKE FEEDER
Ideal for ponies, colts
and small animals



**#69HG-S
SMALL
HAY/GRAIN
FEEDER**
• 28" High
• 21" Wide
• 10" Deep

LARGE SIZE 4 FLAKE FEEDER
Ideal for draft horses



**#69HG-L LARGE
HAY/GRAIN FEEDER**
• 32" High
• 36" Wide
• 16" Deep

MEDIUM SIZE 2 FLAKE FEEDER
4-1/2" Rod Spacing
for easy access to hay

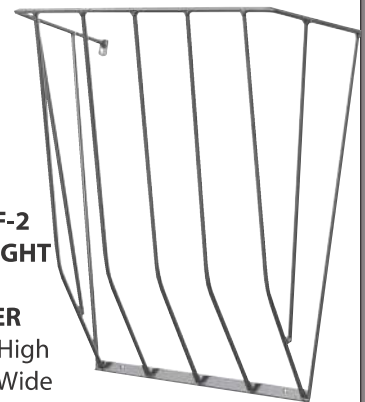

**#69HF-2
STRAIGHT
WALL
FEEDER**
• 30" High
• 29" Wide
• 15" Deep

MEDIUM SIZE 2 FLAKE FEEDER
Ideal for light horses



**#69HG-M
MEDIUM
HAY/GRAIN
FEEDER**
• 32" High
• 24" Wide
• 15" Deep

1 FLAKE HAY FEEDER
4 1/2" Rod Spacing
for easy access to hay

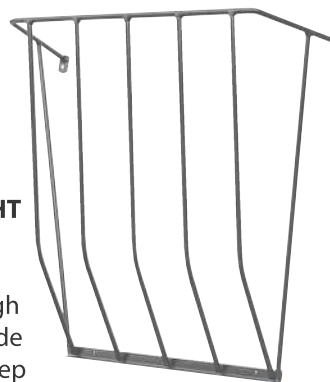

**#69HF-1
STRAIGHT
WALL
FEEDER**
• 30" High
• 27" Wide
• 10" Deep

**DESIGNED TO MOUNT IN A
CORNER**

**#69CHF
CORNER HAY
FEEDER**
• 30" High
• 28" Wide

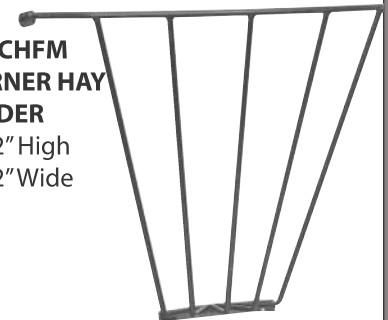

**#69CHFM
CORNER HAY
FEEDER**
• 32" High
• 32" Wide

#9070 CANVAS FEED BAG

Quality canvas bag with a wooden bottom. Has a nylon head band. Handy for in the woods or field so you don't have to unhitch.



HAY BAGS

Rope hay bags are perfect for holding hay at shows, in the trailer or at home. Are available in Black or Blue. Imported.

#9075 36" long.

#9085 42" long.



BLANKETS

Following are our standard blankets but we make special sizes and styles if needed.

(All blankets are also available in pony and mini sizes)

HOW TO MEASURE A BLANKET

Using a tape measure, start from the center of horse's chest and measure around the widest part of the shoulder along the barrel and around the widest part of hindquarters to the center of tail. The blanket measurement is the same as the number of inches measured. For odd numbers go the largest even number.

(Please state size and colour when ordering blankets !)



#30BL TEAR RESISTANT LINED STABLE BLANKET

Our most popular stable blanket, heavy duty upholstery outer material with a lining, comes standard with one surcingle and leg straps, Red, Blue, Green, Burgundy. Standard sizes: 60" - 100"



#10BL LINED DUCK BLANKET

A quality duck outer material with lining, standard with leg straps and 1 surcingle, comes in Red, Blue or Green. Standard sizes: 60" - 100"

#20BL SUMMER SHEET

A quality duck outer material with leg straps & 1 surcingle, Red, Blue, Green, Burgundy with White trim. State size and colour



#80BL FLY SHEET

- Standard features include surcingles and dees and a front strap
- Made from cool mesh scrim sheet
- Available in sizes 68"-100"
- Your choice of trim colour



#34BL LIGHTER DUTY LINED STABLE BLANKET

An Economy stable blanket, lighter duty upholstery outer material with a lining, comes standard with one surcingle and leg straps, Red, Blue, Green, Burgundy. Standard sizes: 60" - 100"



#50BL CORDURA TURNOUT

This rugged and durable turnout rug is made locally with 1000 Denier Cordura, has a 200g polyfill and is lined with quilted nylon.

- Bias surcingles
- Heavy elastic leg straps
- Available from 50"-96"
- Your choice of colour and trim



#7014 OUTSIDE UPHOLSTERY BLANKET

This is warm heavy duty blanket. Has a good lining, meant for outdoors while horse is hitched up to buggy or cart, comes standard with shaft straps. Horse size only.

BLANKETS



#7016 LINED WEATHER RESISTANT BLANKET
A strong light weight weather resistant nylon material made for outdoors with a heavy lining. Comes with leg straps. Sizes: reg or large horse or draft size. Blue, Green or Red.



#7018 CLOSED BEHIND BLANKET
A strong light weight nylon material with heavy lining in closed behind style (Stops the wind from blowing under blanket.) With shaft straps. Sizes: regular or large horse, or draft horse. Blue, Green or Red.



#70BL NYLON RAIN RUG
A 420d waterproof outer shell with wool lining to wick away moisture that is locally made.
• Two surcingles
• Please add #1726 Leg straps to price
• Available in 60"-100"
• Your choice of colour and trim



#8022 BUGGY ROBE
A good quality borg outside and inside with weather resistant material between to make a very warm and comfortable lap blanket for the coldest weather. Size 60" x 72"
Black outside with Red, Green, Blue, Burgundy or purple lining.
#8022 Short Hair (as pictured)
#8022C Child's Size 45" x 54"
#8024 Long Hair

#8028 LAP BLANKETS

A quality checkered polar fleece lap blanket and car seat cover blanket. 75" x 60"

- #8028BL** Blue/Black
- #8028GR** Green/Black



#8020 LINED RUBBER LAP BLANKET
A rubber lap blanket with borg lining. Keeps you dry in wet weather. Size 60" x 72"
Is available with Red, Green, Blue, Black, Burgundy or purple lining.
#8020 Lined (as pictured)
#8026 Unlined

PLEASE NOTE :

We now offer a blanket washing and repair service. Send all your dirty blankets in need of repair and we will take care of them !

#8040 BLANKET PINS

- A good all purpose blanket pin.
- 4" long



WE DO CUSTOM EMROIDERY

Block Script
Brush Script
Custom Script
Russ Times
Diana Script
Typewriter
Old English

WE ALSO OFFER EMBROIDERY SERVICE!
If you're wanting to dress up your blanket with farm logo or name we can do it for you!

HATS - JACKETS - BLANKETS - SADDLE PADS

MISCELLANEOUS

#6920 PLASTIC DURAFORK
#6921 MINI SIZE

- A handy fork around the barn and yard
- Comes in assorted colors



#536 WEATHER STRIPPING

- Clear 12" weather stripping for on shipping doors, barn doors, etc.
- We will cut to your size



#6064W ECONOMY UMBRELLA

- 62" Black golf umbrella
- With spring release action to open
- Good quality and reasonably priced



#6064 HEAVY DUTY UMBRELLA

- 3/4" Fiberglass stem
- 5" rubber grip handle
- Water and wind proof
- Black only
- New and improved inner frame



#3053 BOOT BRUSH

Two brushes that are held in place with horse shoes.



#9010 FELT INSOLES

- White felt.
- Sizes 6-7, 8-9, 10-11, 12-13



#5090-S Aluminum
#5090-P Plastic

- A sturdy adjustable jack
- Makes washing or repairing your wheels a breeze!



#6085 SMV SIGN

- Hi visibility SMV
- #6085** Metal Sign
- #6085P** Plastic Sign

MAIL BOXES

The "Dura-Line" Mail Box is constructed of 1/4" High Density Polyethylene Plastic that will withstand the harsh environment of rural mail boxes.

- Two way flag can easily be seen when coming up the road and likewise from the house
- Heavy duty lid hinge and spring that will not rust
- Large size complies with postal standards
- 10"W x 12"H x 20"L
- All material and labour is Canadian oriented



ARCH TOP

- #3028-RCW** White Textured
- #3028-RW** White Smooth

POSTS WITH SCROLL

- #3028-PBM** Bottom Mount
- #3028-PTM** Top Mount



#278119 MAILBOX NAME PLATE

- Plastic engraved name plates.
- Attach to mailbox with 2 screws.
- 3 1/2" x 8 1/2"
- Green, Blue or Red with White lettering
- White with Black lettering

LOGGING AND TREE TAPPING ACCESSORIES

#25022 TREE TAPPING SUPPLY BELT

- Pocket for spiles
- Hook to carry drill
- Holder for hammer



#25022-V DELUXE VEST FOR MULTIPLE USES

- If installing ,tapping or repairing pipe lines, this is a perfect fit !
- Carry extra hose,tees ect.
- Made with durable material
- Can also make custom made vests



FRONT



BACK

#25018 CHAINSAW TOOL BELT

- Comes with wedge holder, hammer holder, wrench holder (tools not included)



#25018TH LOGGERS TAPE POUCH

A handy pouch made from durable Vinyl material for the tape measure etc.



#25018WH LARGE WEDGE POUCH

- Made with durable PVC material



#25018TWH TRIPLE WEDGE HOLDER

- Carry 3 wedges with this handy pouch !



#10135P VICE GRIP POUCH

A nice leather

pouch for a 5"Vice Grip. Clips onto belt. Black or Brown.



#472 WIRE HAMMER CLIP

- Replacement wire hammer holder



GLOVES

#8031 DRIVING GLOVES

A Black leather sheepskin glove with Thinsulate lining and Velcro wrist closer. Comes in Large and XLarge.



SSG WINTER TRAINING GLOVE

A nice black full grain leather glove with a knit wrist and Thinsulate lining. Is made with the horseman in mind.



#80065 Driving Mitt

Soft sheep skin leather driving mitt with 100 gram thinsulate and elastic wrist.



HYD-TUF WORK GLOVES

Rubber coated palm work glove. A good glove to work with wet or snow covered items. Come in unlined or lined.



- #8006-9 Medium Unlined
- #8006-10 Large Unlined
- #8010-9 Medium Lined
- #8010-10 Large Lined

#80057 HI-VIS KNIT GLOVE

Bright orange PVC with rough finish. Foam fleece lining offers added warmth. Resistant to most oils, acids, greases and solvents



#80059 COTTON GLOVE

White cotton glove with PVC dots on one side for a sure grip when handling wet and dry products. One size only.



#80058 LEATHER WORK GLOVE

Thermolite lined, full-grain leather, elastic wrist and storm cuff to lock in warmth.



L, XL, XXL, XXXL Sizes!

#8008 Horizon Thermo Grip

High-Vis insulated knit rubber palm glove. Brushed acrylic shell for added warmth. Flexible knit wrist seals out dirt. Textured latex for grip and extra wear. Large and X Large.



#80062 Leather Glove

Deerskin leather gloves with an anti-snow glove. Has a Thinsulate C40 detachable lining. Small, Medium, Large and X Large



MISCELLANEOUS BELLS



#170 COPPER COW BELLS

A great item for gift and hardware stores, these cow bells are copper plated over steel.

- Ideal for use on neck straps for cows and sheep, and even on collars of bird dogs
- Larger sizes are nice for taking to ball games and cheering on your team
- Smaller sizes are perfect for use as favours at wedding receptions

- #170-1C 1" L x 1 1/4" W x 1 1/8" H
- #170-114C 1 1/4" L x 1 1/2" W x 1 1/2" H
- #170-134C 1 3/4" L x 2 1/4" W x 2 1/2" H
- #170-138C 1 3/8" L x 1 3/4" W x 2" H
- #170-212C 2 1/2" L x 3 1/4" W x 3 3/4" H



#157 SWISS COW BELL

- Quality constructed from non-rust solid brass
- A reproduction of the "1878 Saignelegier" bell
- Brass or chrome plated over brass finish

- #157-2 2 3/4" #157-3 3 1/4"
- #157-4 3 5/8" #157-6 4 1/2"



#165 CANADIAN BEAVER BELL

- A solid brass bell
- A reproduction of the Beaver Bell
- Brass or chrome plated over brass finish
- 4 3/4" bottom diameter

#157 BELL STRAP

- 1" x 12" Bell Strap for the #157 & #165 bells

- #157-G Granite Strap
- #157-L Leather Strap
- #157-N Nylon Strap



**#145-RW
REPLACEMENT WIRE**



#156W IMPORTED RUMP BELLS

- Economy priced
- Polished brass or chrome plated

- #156W-S 2"
- #156W-M 2 1/2"
- #156W-L 2 3/4"



#161 ARTIC SLEIGH BELLS

- A bell with many uses, for bell hangers, body bells, novelties, etc.
- Brass plated & nickel plated steel
- Hole in bottom for mounting

- #161-1 1" #161-114 1 1/4"
- #161-112 1 1/2"

REPLACEMENT PARTS



#151-150 CLAPPER SET
Yoke, wire and clapper set for the ice cream bells.

#149 BOLT & NUT

- For mounting the #166 bells
- Brass or chrome







TOP CLIPS

- Replacement top part on bells
- Brass Only

- #147-157TC For #157 Bell
- #147-165TC For #156 Bell



RUMP BELLS & BELL DROPS

 <p>#155W RUMP BELLS</p> <ul style="list-style-type: none"> • Designed to buckle under the back strap on the horses rump or back • Quality made from black leather • 4 or 6 Bells of the #156W • Polished brass or chrome <p>#155W-4 4 Bell Strap 2 1/4" x 17"</p> <p>#155W-6 6 Bell Strap 2 1/4" x 23"</p>	 <p>#155M MINI/PONY RUMP BELLS</p> <ul style="list-style-type: none"> • Same as #155 Rump Bells only smaller • 4 Bell only • Polished brass or chrome • 2" x 15" Leather Strap 	 <p>#71 ECONOMY RUMP BELL</p> <ul style="list-style-type: none"> • 2" x 15" Leather strap • With 4 #161 Arctic bells • N.P. Bell and hardware <p>#168 RUMP BELL STRAPS ONLY</p> <ul style="list-style-type: none"> • Need new leather for your rump bells? • Includes everything you need to replace straps <p>#168-4 4 Bell Straps #168-6 6 Bell Straps</p>	<p>#1109 TRIPLE BELL DROPS</p> <ul style="list-style-type: none"> • A nice drop for those winter sleigh rides • 3 #157 Bells • Brass or Chrome <p>#1109L Leather #1109B Biothane #1109G Granite</p>  <p>#1107 SINGLE BELL DROP</p> <ul style="list-style-type: none"> • Can be buckled anywhere on harness • Has 1 #157 Bell • Brass or chrome <p>#1107L Leather #1107B Biothane #1107G Granite</p> 
---	--	---	--

BODY BELLS

#159 BIOTHANE BODY BELLS

- Biothane strap with #161 bells that fastens around the girth of your horse
- Nickel plated or brass plated bells
- Available in Black, Red, Green, Blue

#159D Draft size 1" x 103"
#159H Horse size 1" x 87"
#159P Pony size 3/4" x 65"
#159M Mini size 3/4" x 58"



#158 GRANITE BODY BELL STRAPS

- GRANITE Strap with #161 bells that fastens around the girth of your horse
- Nickel plated or brass plated bells

#158D Draft size 1" x 103"
#158H Horse size 1" x 87"
#158P Pony size 3/4" x 65"
#158M Mini size 3/4" x 58"

DOOR BELL HANGERS

#5613 Horse Door Hanger



#5611 LAB DOG DOOR HANGER



#5612 Draft Horse Door Hanger



DOOR BELL HANGER STRAPS

- 1" x 15 1/2" Leather Strap
- 6 #161-1 1/2" bells
- Brass or Nickel Plated

#5650 with lace
#5650R with ring
Also available with colored beta material.



#145-RC REPLACEMENT CLAPPER

Great choices for Gifts!!

WALLETS, ETC.

#3040 LEATHER WALLETS

Good quality hand crafted stamped leather billfold with leather lace.

- Change purse and credit card holder
- Other designs available!
- We can stamp a name onto the #3040-HHN
- 9 1/2" x 3 3/4"



#3040-PD



#3040-DT



#3040-CB



#3040-WH



#3040-MC



#3040-SC



#3040-HHN



#3040-HH



#3040-RH



Inside View

#3041 LEATHER WALLETS

A beautiful stamped leather trifold.

- Horse head with oak leaves pattern with leather lacing around the outside
- Other designs available
- Lots of room for credit cards
- 9 3/4" x 4 7/8"



#6056 HORSE DIAL THERMOMETER

A beautiful thermometer for your barn wall or backyard.



DIAL THERMOMETER

This 12" dial thermometer comes with a picture of a team in the center. Celsius only.

- #6055-BE** Belgian Team
- #6055-CL** Clydesdale Team
- #6055-PB** Black Percheron
- #6055-PD** Dappled Percheron



#600 HORSE SHOE PUZZLE

Here is a brain teaser. Get your friends to remove the ring!! Is available in Polished Stainless Steel



WEATHER VANES

Rustproof and maintenance free, these weather vanes are constructed from cast aluminum. Can be mounted Vertical, Horizontal and Pitched. Is available in Horse, Horse and Buggy and Rooster.

- #70W** 24" High
- #100W** 30" High

BELT BUCKLES & MISCELLANEOUS

#34F FLORAL BUCKLE

- Sizes 1", 1¼", 1½"
- Stainless steel or Brass



#10BB BELT BUCKLE

- Sizes 1", 1¼", 1½"
- Stainless steel or Brass



#4W BELT BUCKLE

- Sizes 1", 1¼", 1½"
- Stainless steel or Brass



#4016 BIOTHANE BELT BUCKLE

- Just cut belt to size and insert and close clasp.
- Can be used on BioThane Belting and will work on leather as well.
- 1 ¼" wide and POL SS.



#3414 BIOTHANE® BELTS

- Basket weave design in a semi gloss leather look belting.
- No more stretched out holes from the buckle tongue.
- Comes pre-punched, cut to your size and insert in the Bio Thane Buckle.
- Black or Brown.



#3410 LEATHER BELTS

- Handmade belts from good quality leather.
- Black or Brown
- 1", 1 ¼" or 1 ½" widths
- 30" - 50"
- Please specify colour and size when ordering



#1216 HORSE PEN STAND
An unique wooden pen stand with a 3 1/2" horse. Comes with a finished cedar or oak base. Overall size 7" long x 4" wide x 8" high.



#1219 PLASTIC DRAFT HORSE
A great horse for display or play.
#1219-5 3 1/2" high x 5" long



HORSES
Nice hand painted collectible horses. A good choice for replicas. Very solid and durable for children.

#3091-CM Clydesdale Mare
5 1/2" High x 4" Long
#3091-GS Gypsy Vanner Stallion
4 1/4" High x 4" Long



#1212 WOODEN HORSE ROCKER
Every child will love this wooden horse rocker. Comes complete with yarn mane and tail. Unfinished or stained. Over all size 32" long x 1 1/2" wide x 26" high.

SIGNS











PLASTIC SIGNS

These signs are printed on heavy gauge plastic. 110 gauge, are colourfast and are very durable to outside weather conditions. Measure 18" x 18" and have 2 mounting holes.

				
#3014-CH CAUTION HORSE SIGN	#3014-CHB CAUTION HORSE & BUGGY SIGN	#3015-W WHOA STOP SIGN	#3015-WH WHOA HORSE STOP SIGN	#3015-WHB WHOA HORSE & BUGGY STOP SIGN

ALUMINUM SIGNS

These signs are made from aluminum and will never rust. All signs have 2 mounting holes. (Please note: we can get the following signs in many styles and with a wide variety of wording. Please call to see if we can get what you want.)

				
#3020-B BELGIAN XING SIGN 12" x 12"	#3020-CA CARRIAGE XING SIGN 12" x 12"	#3020-CL CLYDESDALE XING SIGN 12" x 12"	#3020-DHW DRAFT HORSE WORKING XING SIGN 12" x 12"	#3020-DH DRAFT HORSE XING SIGN 12" x 12"
				
#3020-HL HAFLINGER XING SIGN 12" x 12"	#3020-MH MINI HORSE XING SIGN 12" x 12"	#3020-PE PERCHERON XING SIGN 12" x 12"	#3020-HC HORSE CAUTION SIGN 12" x 12"	#3020-CC CRITTER XING SIGN 12" x 12"
#3021-EF EVERY FARM NEEDS A TEAM SIGN 12" x 18"	#3021-HP HORSE PARKING ONLY SIGN 12" x 18"	#3021-IYC IF YOU CAN'T SLOW DOWN OR STOP WHEN YOU SEE A HORSE... PLEASE DON'T USE THIS ROAD 12" x 12"	#3022-DFR DRIVING FEED ROOM SIGN 9" x 12"	#3022-DTR DRIVING TACK ROOM SIGN 9" x 12"
	#3023-BDS BEWARE OF DOGS 12" x 6"			#3022-MYMR MY BARN MY RULES SIGN 9" x 12"

CALENDARS

These calendars by Mischka Press are looked for year after year. They feature the best full-colour photography of these magnificent animals in a practical and useful format. The calendar is 12" wide and 19" tall (when opened), with one large colour photo and several smaller color photos for each month.

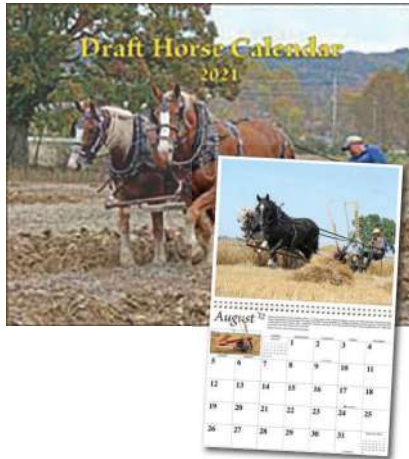

#1210 DRAFT HORSE CALENDAR



#1218 DONKEY CALENDAR



#1214 MULE CALENDAR

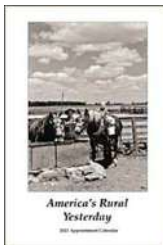

#1225 APPOINTMENT CALENDAR
A week-at-a-glance engagement calendar, America's Rural Yesterday features 55 vintage black and white photos of rural life in the 1920s and 30s. The calendar measures 12" x 9" when opened. By Mischka Press.

#1226 DESK CALENDAR
This calendar stands on its own easel on your desk, featuring one page per month, with a colour photo of draft horses on each page. The calendar measures 4.25" x 5.75". By Mischka Press.

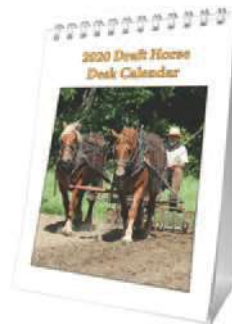

#1211 PERCHERON CALENDAR

BOOKS

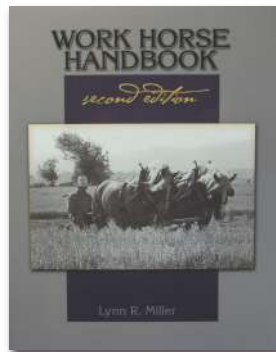

#1200 WORK HORSE HANDBOOK
By Lynn R. Miller
This book covers such topics as: choosing, housing, feeding, harnessing, hitching and working the draft horse. Wonderful photos and drawings help explain the text. A book that every draft horse owner should have. 336 pages. 8 1/2" x 11". Softcover.

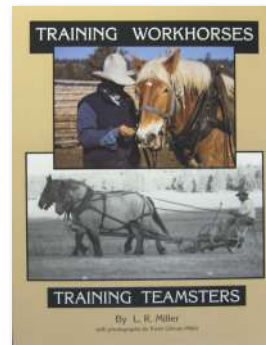

#1202 TRAINING WORKHORSES TRAINING TEAMSTERS
By Lynn R. Miller
This book tells the draft horse owner how to train his horses, giving alternate methods and stressing that working with horses should be a happy, worthwhile experience. 341 pages. 8 1/2" x 11". Softcover.



#1231 HORSEDRAWN PLOWS AND PLOWING By Lynn R. Miller
A very informational book on plows and plowing for draft horses. Covers everything from walking plows to gang plows. Also a chapter on laying out your fields. Lots of pictures and diagrams. 368 pages. 8 1/2" x 11". Softcover.

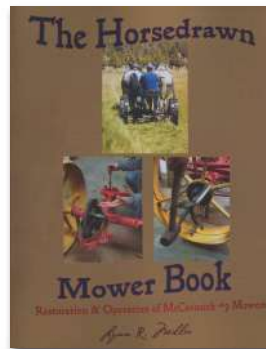

#1234 THE HORSEDRAWN MOWER BOOK By Lynn R. Miller
A complete guide for the restoration & operation of McCormick #9 mowers. Also covers the #7 and John Deere Big Four mower. Has lots of photos and diagrams. 352 pages. 8 1/2" x 11". Softcover.

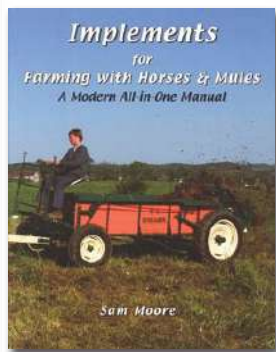

#1235 IMPLEMENTS FOR FARMING WITH HORSES BOOK By Sam Moore
Covers most of the farm implements used with horses today. It not only describes them, but shows you how to use each piece of machinery. Adjust it for good work, and maintain it. Moore provides expert knowledge about tillage equipment, haymaking implements, planting and cultivating machines and a lot more. Over 300 pages. 8 1/2" x 11". Softcover.

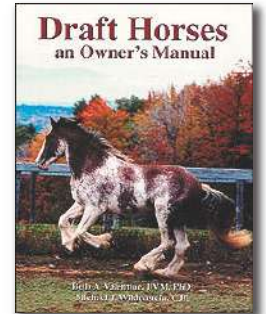

#1236 DRAFT HORSES AN OWNERS MANUAL
By Dr. Beth Valentine, DVM & Michael Wildenstein
Veterinarian Beth Valentine discusses how to gauge your horse's health, special dietary needs of heavy horses, the particular disorders that affect draft horses. Farrier Mike Wildenstein covers how to maintain a sound hoof, judging soundness, and other hoof-related topics. Softcover. 8 1/2" x 11". 238 pages. Hundreds of black and white photos and illustrations.

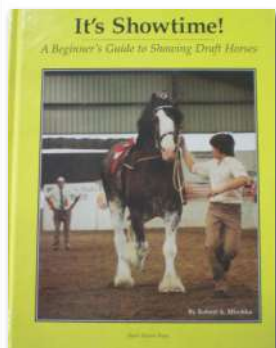

#1197 IT'S SHOWTIME!
By Robert Mischka
This book covers what judges look for, grooming your horse for the show ring, what to bring to the show, how to safely transport horses, showing for the showring, showing at halter and in harness, tail tying, mane rolling, preparation at home. 128 pages. 7 1/2" x 10". Hardcover.

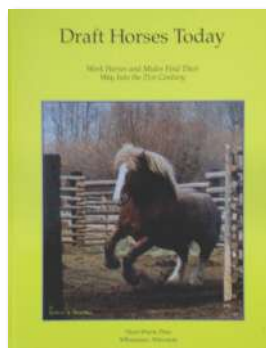

#1201 DRAFT HORSES TODAY
By Robert Mischka
An overview of today's draft horse and mule scene. Chapters on how to find vehicles and equipment for draft horses and learning to use your horses. An excellent book for newcomers or a great gift book. 176 pages. 8 1/2" x 11". Hardcover.

BOOKS

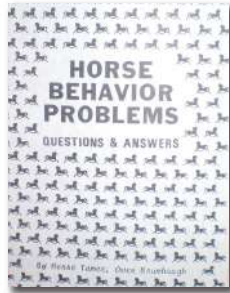

#1221 HORSE BEHAVIOUR PROBLEMS
By Owen Brumbaugh
This book has 60 questions and answers on horse behaviour problems.
48 pages. 5 1/2" x 8 1/2". Paperback.

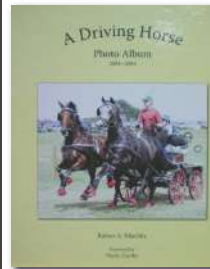

#1233 A DRIVING HORSE PHOTO ALBUM
By Bob Mischka
Every year Bob Mischka takes thousands of photographs of some of the best driving horse turnouts in the world and we chose only a few of the best of his shots from the 2004-2005 season in this book. It is simply the best collection of driving horse photographs available anywhere. 168 pages with over 300 photos. 9" x 11" Hardcover.

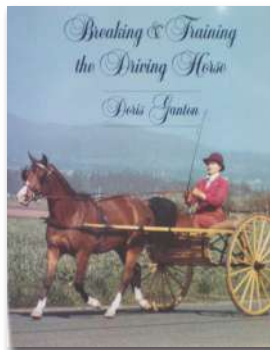

#1222 BREAKING & TRAINING THE DRIVING HORSE
By Doris Ganton
A nice book about the training of a young colt and the education of a novice driver. Easy to follow and well illustrated. 85 pages. 8 1/2" x 11". Softcover.

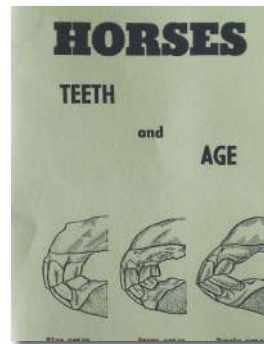

#1223 HORSES TEETH AND AGE
By Owen Brumbaugh
A good book on how to tell your horses age by their teeth. It is well illustrated. 11 pages. 5 1/2" x 8 1/2". Paperback.

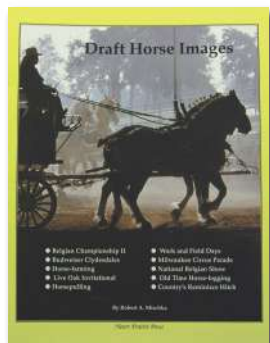

#1228 DRAFT HORSE IMAGES
By Robert Mischka.
Covers the 1992 National Belgian Show, the Belgian Championship II Show, the Live Oak Show and the Milwaukee Circus Parade. Other stories cover the Budweiser and the Reminisce Hitches, the Nevada City (California) Carriage Company, Old-Time Horse Logging, Horsepulling in the midwest, farming with horses and Work and Field Days. 160 pages. 8 1/2" x 11". Softcover.

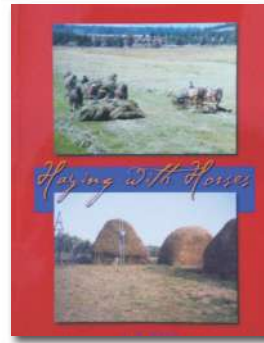

#1206 HAYING WITH HORSES
By Lynn R. Miller
In this big book Miller offers in-depth information on mowers, rakes, hayloaders, buckrakes, stackers, tracks and trollies for barns, hay fork systems, balers, wagons, feed sleds, forecart adaptations and much more. It also covers how to build loose hay stacks and wagon loads as well as unloading and feeding systems. 366 pages. Hundreds of illustrations. 8 1/2" x 11". Softcover.

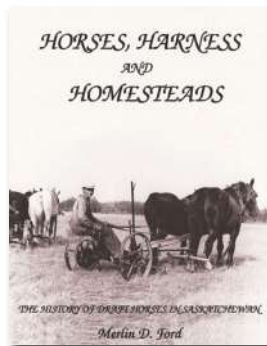

#1242 HORSES, HARNESS AND HOMESTEADS
By Merlin D. Ford
Do you know how they did farming on the western prairies in the early 1900's in Saskatchewan? This book is both an album of historic photographs and a history of the important role that Saskatchewan's horse breeders played in supplying the draft horses so needed to power the first agricultural operations in Saskatchewan. This is a book that Western Canadians will enjoy! 240 pages. 8 1/2 x 11. Softcover.

BOOKS

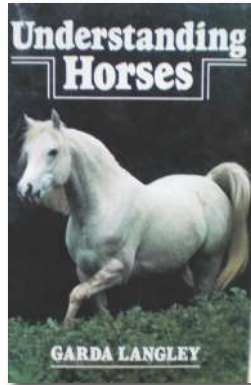

#1227 UNDERSTANDING HORSES
By Garda Langley.
A great book to get to know your horse better.
216 pages.
5 1/4" x 8 1/4". Softcover.

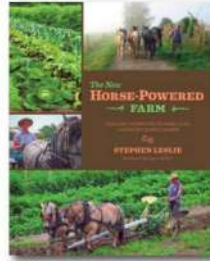

#1244 THE NEW HORSE-POWERED FARM
By Steven Leslie.
The first book of its kind focusing on small scale commercial vegetable farming with horses. Although this book is geared towards market gardening, much of the information applies to all kinds of horse-powered farming. Covers necessary information for experienced and novice teamsters

in getting started with workhorses, merits of different draft breeds, various training systems for both horse and teamster, haying, seeding, and raising small grains, in-depth coverage of tool systems, managing a woodlot, farming economics, education, agritourism. A comprehensive resource directory is also included. 346 pages. 8" x 10". Softcover

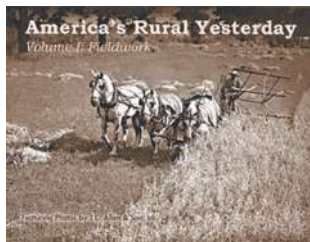

#1256 AMERICA'S RURAL YESTERDAY FIELDWORK, Volume I

- This book covers many aspects of horse farming in black & white photos, very real old time farming
- 11"x8.6" softcover

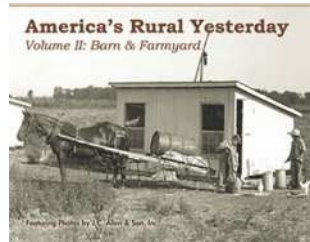

#1257 AMERICA'S RURAL YESTERDAY BARN & FARMYARD, Volume II

The second book in our 3 volume set. More than 120 photographs, many that have never been published before
11" x 8.5" softcover 154 pages



#1258 AMERICA'S RURAL YESTERDAY AT HOME & IN TOWN, Volume III

the third book in our 3 volume set, what people did when they weren't working in the fields, barns or farmyards in the 1920s-1940s. Photos of going to town and spending time at the library, grocery or general stores, school and doctor's office

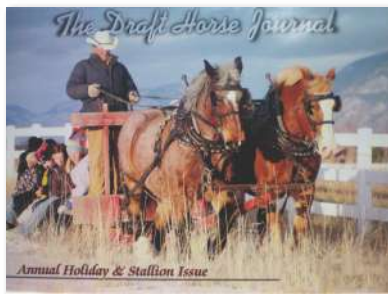

#1196 THE DRAFT HORSE JOURNAL

A magazine for the draft horse lovers. Published quarterly. Covers farming, shows, pulling and horse auctions etc. A beautiful magazine with lots of colour.
8" x 11".

Call to request discounted past editions



#1262 America's Rural Yesterday - Early Tractors

The fourth book is here! Photos of dozens of tractor brands from the early to mid 20th century. The photos showcase tractors when they were brand new; most photos show them working in the fields.



#1198 SMALL FARMERS JOURNAL
A quarterly journal that covers the topics of natural farming and stock raising, alternative farm research/inquiry, horsedrawn implement research & development, horsedrawn equipment sales, and related education. Interesting reading for the farm minded individual.
10 1/2" x 13 1/2".

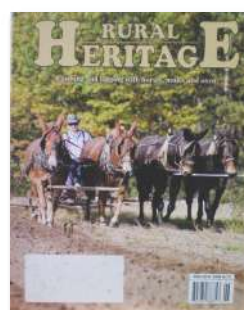

#1195 RURAL HERITAGE MAGAZINE

Printed by Mischka Press
A magazine that covers the topics of farming and logging with horses, mules and oxen. Is printed bi-monthly. 8 1/2" x 11".

Call to request discounted past editions

CLOCKS & MIRRORS



WALL CLOCKS

A great gift idea for the horse lover!
An 11" dial clock that has picture of a team in the center.

- #94-B Belgian Team
- #94-CL Clydesdale Team
- #94-PB Black Percheron
- #94-PD Dapple Percheron



#95N LARGE COLLAR CLOCK

This is a black collar clock with gold lined numbers. A crushed velvet face that is available in Black, Blue, Green or Red. Overall size 14" x 20"

- Also available with Westminster or Bim Bam movement.



#96 COLLAR MIRROR

A beautiful collar with a mirror in the center. Black or Brown. Overall size 14" x 20"



#109 MINI COLLAR MIRROR

A miniature copy of the #96 Collar Mirror. Black or Brown. Overall size is 4" x 6"



#108 MINI COLLAR CLOCK

- Beautiful handmade clock with chrome hames
- Size 7" x 15"
- Uses 1 AA battery
- Available in Black and Brown with red, blue, green & black face



#95W-D Wooden Laser Engraved Clock with Deer



#95W-DO Wooden Laser Engraved Clock with Dog



#3052 BARNYARD COLLAR MIRROR

This collar mirror has old time hames for that old time look. Overall size 17" x 21"



#105 HITCHING POST

Cast iron horse head hitching post. With 2" threaded pipe coupler. Black only.

ROPE, ETC.

#425C COTTON ROPE

- Bulk cotton rope that is soft and smooth on the hands
- Available in 1/2", 5/8", 3/4" and 1"

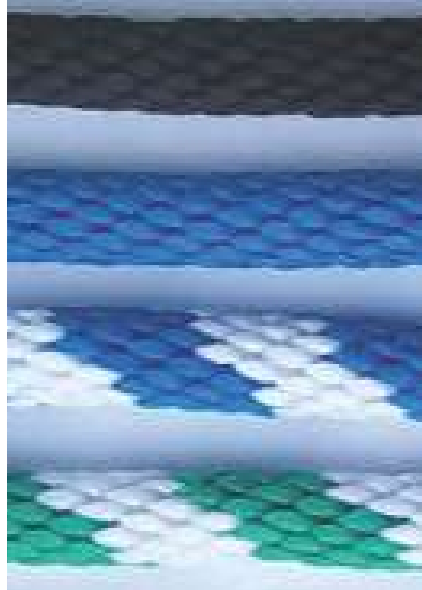

#425SB SOLID BRAIDED POLYPROPYLENE ROPE

- Nice and soft, solid braided multifilament polypropylene rope
- Washable
 - 1/4", 3/8", 1/2" and 5/8"
 - Black, Blue, Blue/White and Green/White are in stock
 - See Next Page for color Options



#425T TWISTED POLYPROPYLENE ROPE

- 3-Ply twisted polypropylene rope. A good choice for a lead rope and neck rope.
- 1/4", 5/16", 1/2" and 5/8" in Yellow
 - 1/2" in Black, Blue, Burgundy, Green and Red with a White tracer
 - See next page for color options.

#425S SISAL ROPE

- An old fashioned Sisal rope
- 1/2" only



- #425-RP ROPE PLIERS**
Pliers to install wire clamps onto rope



- #1009 ROPE CLAMPS**
Wire clamps to use on rope ends
- 3/16", 5/16", 3/8", 1/2", 5/8"



- #1011 ROPE THIMBLE**
- BR, SS
 - 1/2", 5/8"



- #1010 ROPE CLAMPS**
- 1/2", 5/8", 3/4"
 - Zinc plated



- #1010 ROPE CLAMPS**
- Heavy Duty
 - BR, SS 5/8"

HARNESSE CARE OILS

#518S SHEPS NEATSLERNE HARNESSE OIL

The preferred choice of harness makers! This harness oil offers the right combination of pure neatsfoot oil and other specially tempered oils. Softens, preserves and renews while strengthening and waterproofing leather. Exclusive rat and mice deterrent helps prevent damage from rodents. Great for farm and driving harnesses, horse collars, saddles, bridles, strap goods, work shoes and boots and more.



Black (Has a dye added to blacken leather)

- #518SB-Q Quart Size (1 L)
- #518SB-G Gallon Size (4 L)
- #518SB-5 5 Gallon Pail

Clear

- #518SC-Q Quart Size (1 L)
- #518SC-G Gallon Size (4 L)
- #518SC-5 5 Gallon Pail
- #518SC-55 55 Gallon Drum

#521S

SHEPS 100% PURE NEATSFOT OIL

Reconditions and preserves leather items. Blended for uniformity and penetration. Preserves, strengthens and waterproofs leather. Ideal for work shoes and boots, belts, golf bags, saddles, bridles, harnesses, horse collars, gun cases and more. Best when warmed to 80-90 F.



- #521S-8 8 oz Size (237 ml)
- #521S-P Pint Size (474 ml)
- #521S-Q Quart Size (1 L)
- #521S-G Gallon Size (4 L)
- #521S-5 5 Gallon Pail

#519 FIEBINGS BLACK LEATHER STAIN

Gives a darker finish to leather when added to any oil.



#522S FIEBING'S SADDLE SOAP PASTE

Cleans leather and lubricates the fibres to prevent brittleness all the while maintaining suppleness and strength. Can be used on fine saddlery, boots, shoes and other leather articles.

- #522S-12B 12 oz Black Soap
- #522S-12Y 12 oz Yellow Soap

#522SL FIEBING'S LIQUID SADDLE SOAP

A liquid glycerine saddle soap that will clean and preserve saddlery and all smooth leather articles. Easy to use; just spray and wipe. Buffs to a rich satin finish.

- #522SL-P Pint Size (473 ml)
- #522SL-Q Quart Size (946 ml)



HORSEMAN'S ONE STEP

A one step leather cleaning and conditioning cream that contains three cleaning agents. It removes dirt, sweat and salt, while helping to restore a natural shine. Leaves no greasy residue and will not darken most leathers.

- #8018 15 oz (425 gr)
- #8019 7 lb Pail (3.2 kg)

#1143 TUFF AND GLOSSY LEATHER FINISH

A fine black acrylic leather finish. A flexible and durable water repellent finish for dyed, antiqued or polished leather. Can also be used as a dye and finish combination with only one application.



- #1143-Q Quart
- #1143-G Gallon

#8015 KO-CHO-LINE LEATHER DRESSING

Renovates, softens, preserves and waterproofs all types of leather saddlery and accessories. Apply with dry cloth and rub in well.



LEATHER NEW

Cleans, conditions and polishes all in one easy step! Just spray it on and rub it in and it will soften and renew leather and then dries to a long-lasting shine. No oily residue and will not dull or stain.

- #8010 Pint Size 473 ml
- #8012 Quart Size 946 ml
- #8013 Jug Size 1.9L



#479 LEXOL LEATHER CLEANER

Here is non-alkaline cleaner that will clean leather safely and thoroughly. 500 ml sprayer bottle.



LEATHER DYES

FIEBING'S LEATHER DYE

The most recognized penetrating, alcohol-based leather dye on the market. Dries uniformly and mixes easily to create interesting middle tones.

- #1160-4 Black 4 oz.
- #1160-1 Black Quart (1 L)
- #1160-1DB Dark Brown Quart (1 L)
- #1160-1MB Medium Brown Quart (1 L)
- #1160-G Black Gallon (4 L)



FIEBING'S PROFESSIONAL OIL DYE

An outstanding new oil-based dye which has an excellent coverage and even drying for high quality results.

- #1160PO-4 Black 4 oz.
- #1160PO-1 Black Quart (1 L)
- #1160PO-G Black Gallons (4 L)



#1149-GBK FIEBING EDGE DYE

- Black
- A lasting permanent dye for coloring etches
- Penetrates deeply
- When dry, can be buffed to a high gloss
- Comes in gallon size



EXACT TOUCH

A fast-drying acrylic edge paint with a flat finish. Waterproof finish resists bleeding. Great for hand painting edges. Cannot freeze.

- #1147Q-BK Black Quart (1 L)
- #1147Q-BR Brown Quart (1 L)
- #1147Q-W White Quart (1 L)



FIEBING'S EDGE DYE FINISH WITH APPLICATOR

Dye and applicator in one convenient container for easy use. A quick and professional way to edge leather goods. May not freeze.

- #1149-BK Black 4 oz.
- #1149-BR Brown 4 oz.



HARDWARE AND METAL CLEANERS

#474 BRASSO

Cleans brass, copper, chrome and other metals. Apply liquid with a soft cloth, let surface dry, then polish to a high shine. A quick way to clean hardware. 235ml Container.



#471 NEVRDULL MAGIC WADDING POLISH

- Polishes chromed and stainless steel.
- Removes rust and corrosion.



#476 Silvo

Gently cleans and polishes silver, gold and chrome. Contains no harsh abrasives, mercury or acids. A creamy liquid polish that leaves a smooth and shiny surface. 142 ml container.



HARNESS MAKING PATTERNS

All these patterns are available in Red, Blue, Yellow, Brown and Green Biothane sheeting.

<p>#1176 TRACE FLARE PATTERNS</p> <ul style="list-style-type: none"> • Leather, biothane or granite • Plain or spotted (Brass or SS Spots) • Draft, Horse, Pony or Mini size 	<p>#1163 BREECHING TOP PAD</p> <ul style="list-style-type: none"> • Leather, biothane or granite • Draft, Horse, Pony or Mini size 	<p>#2010 TRACE FLARE PATTERNS</p> <p>This pattern is used on our pulling and parade harness</p> <ul style="list-style-type: none"> • Leather, biothane or granite • Plain or spotted • Draft or horse size
<p>#1176 TRACE FLARE PATTERNS</p> <ul style="list-style-type: none"> • Leather, biothane or granite • Plain or spotted (Brass or SS Spots) • Draft, Horse, Pony or Mini size 	<p>BREECHING SIDE PAD</p> <ul style="list-style-type: none"> • Leather, biothane or granite #1162 Draft and horse size #1162P Pony size #1162M Mini size 	<p>#2012 BACK BAND PATTERN</p> <p>This pattern is used on our pulling and parade harness</p> <ul style="list-style-type: none"> • Leather, biothane or granite • Plain or spotted • Draft or horse size
<p>#1177 BACK BAND PATTERNS</p> <ul style="list-style-type: none"> • Leather, biothane or granite • Plain or spotted (Brass or SS Spots) • Draft, Horse, Pony or Mini size 	<p>NOSE BAND BRACES</p> <ul style="list-style-type: none"> • Leather, biothane or granite #490 Draft and horse size #490P Pony and Mini size 	<p>#2014 BACK BAND SIDE PATTERN</p> <p>This pattern is used on our pulling and parade harness</p> <ul style="list-style-type: none"> • Leather, biothane or granite • Plain or spotted • Draft or horse size
<p>#1190 BACK BAND FELT</p> <ul style="list-style-type: none"> • Made from 1/2" black polyester felt • Ready to sew on • Draft, Horse, Pony and Mini size 	<p>#2016 BREECHING TOP PATTERN</p> <p>This pattern is used on our pulling and parade harness</p> <ul style="list-style-type: none"> • Leather, biothane or granite • Plain or spotted • Draft or horse size 	<p>#2016 BREECHING TOP PATTERN</p> <p>This pattern is used on our pulling and parade harness</p> <ul style="list-style-type: none"> • Leather, biothane or granite • Plain or spotted • Draft or horse size
<p>#1178 BACK BAND SIDE PATTERNS</p> <ul style="list-style-type: none"> • Leather, biothane or granite • Plain or spotted (Brass or SS Spots) • Draft, Horse, Pony or Mini size 	<p>#2018 KIDNEY DROP PATTERN</p> <ul style="list-style-type: none"> • Leather, biothane or granite • Plain or spotted • Draft or horse size 	<p>#2017 BUCKLE PAD PATTERN</p> <p>Pattern used to sew buckles onto</p> <ul style="list-style-type: none"> • Leather, biothane or granite • Plain or spotted • Draft or horse size

BLINDS & CUPS



#620 ROUND PATENT BLINDS
#620-5H 1/2" Horse size
#620-6H 5/8" Horse size
#620-7H 3/4" Horse size
#620-5C 1/2" Cob size
#620-6C 5/8" Cob size
#620-5P 1/2" Pony size
#620-6P 5/8" Pony size
#620-5M 1/2" Miniature size



URETHANE BOX LOOP CUPS & #4 BUCKLES
#630-7H round horse size bio. 3/4"
#630-7HG round horse size granite 3/4"
#630-7C round cob size bio. 5/8"
#630-7CG round cob size granite 5/8"
#630-7P round pony size bio 5/8"
#630-7PG round pony size granite 5/8"
#632-7H square horse size bio 3/4"
#632-7HG square horse size granite 3/4"

1 1/2" SEW ON TRACES

- Made with the most durable material available with molded in slots that will not wear or tear!

#2001B-90 90" Bio. Traces with slots
#2001B-98 98" Bio. Traces with slots
#2001G-90 90" Granite Traces with slots



#626-DUWS Draft Blind Cup
 • Urethane blind cup with stay
 • Draft size only



#624 ROUND CUPS
#624-6D Plain leather Draft
#624-2D Patent leather Draft
#624-DU Urethane Draft
#624-6H Plain leather Horse
#624-2H Patent leather Horse
#624-HU Urethane Horse
#624-PU Urethane Pony
#624-6P Plain leather Pony
#624-2P Patent leather Pony
#624-MU Urethane Mini
#624-6M Plain leather Mini
#624-2M Patent leather Mini



#626 SQUARE CUPS

#626-6D Plain Leather Draft size
#626-2D Patent Leather Draft size
#626-6H Plain Leather Horse size
#626-2H Patent Leather Horse size
#626-HU Urethane Horse Size
#626-CU Urethane Cob Size
#626-6P Plain Leather Pony size
#626-2P Patent Leather Pony size
#626-PO Urethane Pony Size
#626-6M Plain Leather Mini size
#626-2M Patent Leather Mini size



#625 Pigeon Wing Blinds
 • Available in leather or biothane
 • Draft, Horse, Pony and Mini sizes available



#528 BLIND TINS
 • Round or square
 • Flat or cupped
 Sizes: • Draft • Horse • Pony • Mini

#117-149-34 URETHANE BOX LOOPS
 • Box loop only
 • Formed Pattern
 • Can be used with blinds or open cheek pattern



#120-149 BOX LOOP CHEEKS
 • 3/4" wide
 • 5/8" wide



OPEN FLARED CHEEKS
#117-148 Biothane
#417-148 Granite



LEATHER WINKER STAYS
#110H-41 Horse size
#110P-41 Pony size
#110M-41 Mini size

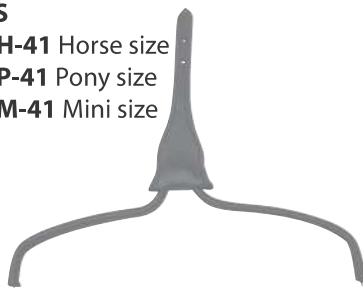

#41 URETHANE WINKER STAYS
 • Draft, Horse, Pony, Mini
 • Also available with biothane or granite holder sewn on

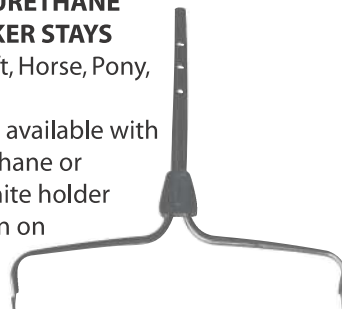

#120-41 LEATHER WINKER STAYS
 • Used on #120-38 bridles

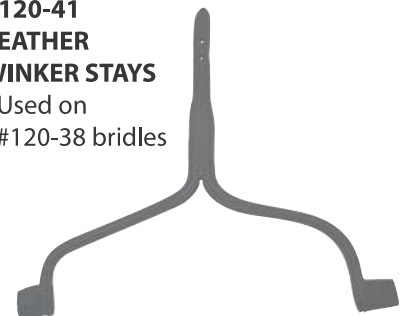

MATERIALS



#1158 BIOTHANE SHEETING
A glossy, durable material Comes in 24" wide. Used in many harness applications. Easy to die cut. A bio plastic product.



#1166 SHEETING

New and improved sheeting that is plyable and will stand up to cold temperatures. Great for patterns, Scotch tops etc.

#1166-332 3/32" thick x 42" wide
#1166-142 .142" thick x 24" wide

• **Coloured sheets**

- Comes in 30" x 49" sheets
- Available in 1/8" & 3/16"
- Sold per square foot



#1168 PVC SHEETING (COATED MESH)

Tough, smooth dull black material. Matches well with granite and nylon material. Used for different patterns.

#1168-15

1/8" thick x 15" wide

#1168L-18

1/16" thick x 18" wide



#1168R RED RUBBER

A soft orange rubber material. Has no strength. Used for inner pieces where harness parts are wrapped. 1/8" thick



#1167-ST SEW-TUFF SYNTHETIC MATERIAL

This is a popular material used in the sports industry, very durable to abrasion and easy to work with. Used on most of our belly bands, breeching seats and breastcollars.

#1167-WS WINTERSPORT

Has a little more stretch and can also be used to roll and wrap harness parts. Also, commonly used in upholstery
Black 54" wide



#1167-N NEOPRENE

A soft, pimply material. Can be used instead of #1167-C if you want more padding. Available in Black and Brown



#1159W WHITE PATINA

A high gloss patent leather finish on synthetic backing. Used on dash boards and fenders.

62 mill x 54" wide



#1159S-65 PATINA

A high gloss patent leather finish on synthetic backing. Used to roll brow bands, on buggy dash boards and fenders.

65 mill x 54" wide Black



#1156P POLYESTER FELT

High quality 100% polyester.

- Ideal for making saddle pads and lining breast collars, cinches, halters and other tack
- Measures 66" wide
- Sold per yard off the roll

#1156P-38WH 3/8" White

#1156P-12BK 1/2" Black

#1156P-1BK 1" Black

#1172 BLACK MERCURY MATERIAL

A coated wind and water proof material, very durable, we use this for our manure bags.
Black 62" wide



#1152 BORG (OR FAKE FUR)

A good grade of borg we use on our #312, #401, #402, #400 pads, comes in Black, Blue, Green, Red, Purple, Burgundy, Dark Green. 60" wide

MISCELLANEOUS & MATERIALS



#18 COLLAR CAP
• Small, medium or large



#1720 BLANKET FRONT STRAP
• Leather
• Lightweight or heavyweight
• Black, Tan or Burgundy



#1179 LEATHER BACK BAND PAD
• Mini size
• Pony size
• Horse size 16" x 4"



#1193 BACK BAND FILLER PAD
• Leather
• Granite
• Sheeting



HOOK & LOOP
• Plain backing
• Black standard colour
#1705-34 3/4" wide
#1705-1 1" wide
#1705-2 2" wide
#1705A-1 1 Adhesive Back
Sticks to any surface



#497 COLLAR STRAP
• 1" and 1 1/4"
• 12" long



#1722 NYLON BLANKET FRONT STRAP
• Double ply nylon
#1722-BP Buckle pc. only - less buckle
#1722-FS Front strap only
• Black, Red, Blue or Green



#1171 SOLID ROUND PLASTIC ROD
For stiffening scotch top, etc.
• Comes in 8 foot lengths
• 3/8" or 5/16" diameter



LEATHER CROOPER DOCK
• Stuffed with flax seed
#609 Mini size
#610 Pony size
#612 Horse size
#614 Draft size
• Black or Russet



#1170 POLYURETHANE BEADING
Ideal for making those patent rims along flat chains, etc. In place of cane. Will not break and is very nice to work with.
• 3 mm thick (1/8")
• 4 mm thick (5/32")



1167-ST SEW-TUFF SYNTHETIC MATERIAL
• 54" wide rolls, Black on 1 side
• A new product we have been using to roll belly bands, breaching seats, cuts easy and stretches, wears very well !



URETHANE CROOPER DOCK
#610W Mini & Pony size
#616W Horse size
#617W Draft size



#535 CUTTING BOARD
Polypropylene cutting board. Helps save the sharp edge on your tools.
• 4' x 8' Sheets. But will cut to your specs
• Available in 1/8", 1/4", 1/2" and 3/8"
• Other sizes available on request
#25075 CUTTING BOARD
Precut from the above board.
• 12" x 18"



BioThane® product number chart





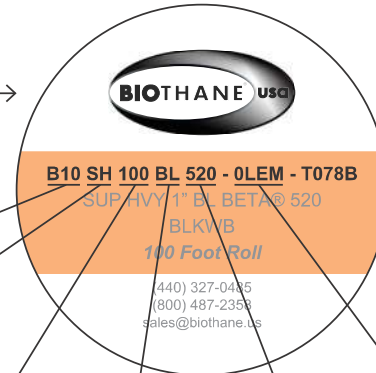









All BioThane® Rolled Goods are labeled with a product sticker. →

Visit aaronmartin.com for color options.



WEBBING B10 1000 pound/453kg break strength		PROFILE SH super heavy .150"/3.8mm	WIDTH 100 1"/25mm	COLOR BL black	COATING 520 Beta®	EMBOSS OLEM leather emboss
--	---	--	---------------------------------------	---------------------------------	---------------------------------------	--

POSSIBLE OPTIONS

WEBBING	PROFILE	WIDTH	COLOR	COATING	EMBOSS
B05 400 pound break strength PER INCH OF WIDTH OR 181kg break strength PER 22MM OF WIDTH		UT ultra thin .035"/.9mm	BL black	100's Gold opaque	0050 50'/15m roll no emboss
* B10 1000 pound break strength PER INCH OF WIDTH OR 453kg break strength PER 22MM OF WIDTH		SF super flex .060"/1.5mm	BR brown	300's Gold translucent	0100 100'/30m roll no emboss
B30 3000 pound break strength PER INCH OF WIDTH OR 1360kg break strength PER 22MM OF WIDTH		HF high flex .080"/2mm	BU blue	230's Granite®	0200 200'/61m roll no emboss
		ST standard .100"/2.5mm	GN green	280's Granite®	OSEM sand emboss
		G2 grooved .100"/2.5mm	GY grey	400's Diamond	* OLEM leather emboss
		SB beaded .160"/4.1mm	OR orange	431's Griamond®	
		X2 extra thick 2 grooved .130"/3.3mm	PK pink	480's Griamond®	
		* SH super heavy .150"/3.8mm	RD red	* 520's Beta®	
		S2 super heavy 2 grooved .150"/3.8mm	SI silver	560's Beta®	
		TK super thick .185"/4.7mm	TN tan	951 Foam	
		T2 super thick 2 grooved .185"/4.7mm	TU turquoise	961 Foam	
		QT quarter thick .250"/6.4mm	VI violet		
		QT super grip .250"/6.4mm	WH white		
		CR coated rope call for details	WN wine		
			YE yellow		



* OPTIONS USED IN EXAMPLE AT TOP OF PAGE

BIOTHANE GLOSSY BELTING (100,300,400 SERIES)

Genuine Biothane is: Waterproof, Easy to Clean, Will Not: Mildew, Harbour Bacteria, Crack or Dry Out
All of our Biothane products are manufactured by Biothane Coated Webbing Corp. We have been using their products on all of our harnesses for many years with good success and can highly recommend them.
(If you are needing a size, weight or colour of belting not shown here, please ask our staff as we can possibly get it for you!)

Biothane is made with a strong polyester webbing inside with the following outer finishes
Diamond – Shiny Gloss | Griamond – Semi Gloss | Beta- Dull with Leather Emboss

STANDARD BIOTHANE

Durable plastic coated webbing. Used for harness, tack and pet supplies.
2.55mm thickness. 100 Feet per roll. Surcharge applies for part rolls.

Glossy Plain Biothane-Availabe in the following colors:

10-Black 11-Blue 13-Burgundy 14- Dark Blue 15-Silver
18-Neon Green 19-Orange 20-Pink 22-Purple 23-Red
24-Turquoise 25-Yellow 31-White 38-Lt Blue
41-Camo Green 42-Camo Orange 43-Camo Pink
44-Cam Blue

Size	Item #	Colors Available
½"	#20-012 (add color #)	All colors except Camo
5/8"	#20-058	Black Only
¾"	#20-034 (add color #)	All Colors
1"	#20-100 (add color #)	All Colors
1 ½"	#20-112 (add color #)	All colors except Camo



2 GROOVED DIAMOND

- 2 Grooved Diamond is very durable plastic webbing that comes in 3 finishes used for harness, tack and pet supplies.
- Standard weight Biothane is 2.55mm thick
- 100 Feet per roll.
- Surcharge applies for part rolls.



REFLECTIVE BIOTHANE

• Durable with a high gloss finish and a strip of reflective in center. Used for harness, tack and pet products.

Reflective available in these colors
#10-Black #11-Blue #14-Dark Green
#18 Neon Green #19-Orange #20-Pink
#22-Purple #23-Red #25-Yellow

Size	Item #	
¾"	#25-034 (plus color #)	Available in all colors
1"	#25-100 (plus color #)	Available in all colors

Standard Weight (#21 = Standard)

Heavy Weight (#22 = Heavy available in Black Only)

Size	Item #	
½"	#21-012-10	2 Grooved
5/8"	#21-058-10	2 Grooved
¾"	#21-034-10 & #22-034-10	2 Grooved
7/8"	#21-078-10	2 Grooved
1"	#21-100-10 & #22-100-10	2 Grooved
1 1/8"	#21-118-10	2 Grooved
1 ¼"	#21-114-10 & #22-114-10	2 Grooved
1 ½"	#21-112-10 & #22-112-10	2 Grooved
2"	#21-200-10	2 Grooved
2"	#23-200-10	3 Grooved
2 ½"	#21-121-10	2 Grooved
3"	#21-300-10	2 Grooved
New !		
1"	#55-100-10	B20 Extra Thick
1"	#57-100-10	B30 Super Heavy
1 ½"	#57-112-10	B30 Super Heavy

GRIAMOND 480 STRAPS, FOAM, BETA ROPE, SUPER GRIP BETA

• 2 GROOVED GRIAMOND

- Standard and Heavy Weight
- Griamond material has a strong polyester webbing with PVC semi gloss coating, most popular for harness making!

Standard Weight (#41 = Standard)

Heavy Weight (#42 = Heavy available in Black Only)



Size	Item #	
1/2"	#41-012-10	2 Grooved
5/8"	#41-058-10	2 Grooved
3/4"	#41-034-10 & #42-034-10	2 Grooved
7/8"	#41-078-10	2 Grooved
1"	#41-100-10 & #42-100-10	2 Grooved
1 1/8"	#41-118-10	2 Grooved
1 1/4"	#41-114-10 & #42-114-10	2 Grooved
1 1/2"	#41-112-10 & #42-112-10	2 Grooved
2"	#41-200-10	2 Grooved
2"	#43-200-10	3 Grooved **
2 1/2"	#41-121-10	2 Grooved
3"	#41-300-10	2 Grooved
New !		
1"	#56-100-10	B20 Extra Thick
1"	#58-100-10	B30 Super Heavy

SUPER GRIP BETA

- Soft pliable with large pimples grip.
- Use on end of lines for extra grip.
- 6.35mm Thickness
- 50 Feet per rolls

**5/8" and 3/4"
Super Grip
Now Available in
Colours!**



Size	Item #	Color
5/8"	#32-058-10	Black
3/4"	#32-034-10	Black
3/4"	#32-034-12	Brown
7/8"	#32-078-10	Black
7/8"	#32-078-12	Brown
New! Super Soft Less Pimples		
3/4"	#33-034-10	Black
3/4"	#33-034-27	Brown
7/8"	#33-078-10	Black
1"	#33-100-10	Black

SUPER HEAVY FOAM

Smooth, matte leather look finish. Great for lining belly bands, Breeching seats etc. 3.60mm Thickness. 100 Feet per roll. Surcharge applies for part rolls.



Size	Item #	Colors Available
2"	#35-200-10	Black
3"	#35-300-10	Black

Granite – Beta Rope

- sold per foot, or in 100ft rolls
- #49** 5/16 Granite rope colours #10-Black #11-Blue #19-Orange #20-Pink #23-Red #36-Neon Yellow #38-Lt Blue
- **#39** 1/4" Beta Rope comes in the following colors



Teal TE52I	Magenta PK526	Lagoon BU52F	Sea Foam GN52K
Royal Blue BU522	Neon Yellow YE527	Baby Blue BU52H	Turquoise TU52I
Purple VI52I	Red RD522	Neon Pink PK52I	Neon Orange OR522
Neon Green GN528	Sage Green GN527	Dark Brown BR523	Amethyst PU524
Lavender PU522	Sky Blue BU52I	Black BL520	

Size	Item #	Colors
5/16"	#49-516 (plus color #)	See description
Beta		
1/4"	#39-014-plus color #	See description
5/16"	#39-516-plus color #	See description

BIOTHANE BETA SERIES (520)

Beta is made with polyester webbing core with a soft pliable rubber coating and has a leather emboss finish, very popular for driving lines, tack items and an excellent material for pet leads and collars ! Many colors and widths in stock.



#31 BETA SUPER HEAVY (ABOUT 4 MM)

Popular for driving lines, halters and dog gear.
Available in 1/2", 5/8", 3/4", 7/8", 1", 1-1/4", 1-1/2", and 2" widths
Sizes are available in most colours list below, except 7/8" and 1-1/4"



#30 BETA STANDARD (ABOUT 2.5 MM)

Popular for dog gear, halters and overlay.
Available in 3/8", 1/2", 5/8", 3/4", 1", and 1-1/2" widths
Sizes are available in most colours list below



#61 BETA ADJUSTABLE (ABOUT 2 MM)
Popular for dog gear, halters and overlay. More flexible and works with weblides.

Available in 3/8", 5/8", 3/4", and 1" widths
Sizes are available in **limited** colours



#29 BETA STANDARD FRELECTIVE (ABOUT 2.5 MM)

Popular for dog gear, halters and overlay.
Available in 3/4", and 1" widths
Sizes are available in **limited** colours

Colours Offered	
Number	Description
11	Royal Blue BU522
13	Wine WN521
15	Grey GY523
16	Hunter Green GN522
17	Navy BU523
18	Neon Green GN528
19	Neon Orange OR522
20	Neon Pink PK521
21	Pastel Pink PK522
22	Violet VI521
23	Red RD522
24	Baby Blue BU52H
25	Yellow YE521
27	Dark Brown BR523
31	White WH521
32	Tan BR521
35	Lavender PU522
36	Neon Yellow YE527
37	Lagoon BU52F
39	Sea Foam GN52K
40	Teal TE521
43	Magenta PK526
44	Sage Green GN527
45	Sky Blue BU521
50	Lime Green GN525
51	Med Orange OR529
52	Medium PinkPK523
54	Coral PC524
57	Med.Brown BR522
58	Olive Drab OD521
59	Sahara Tan TN525
60	Amethyst PU524
61	Turquoise TU521
62	Periwinkle BU525

Width Code	
3/8"	038
1/2"	012
5/8"	058
3/4"	034
7/8"	078
1"	100
1-1/4"	114
1-1/2"	112
2"	200

Item Number Structure <profile number>-<width code>-<colour number>
For example **30-012-13** would be **1/2" Standard Beta Wine WN521**

NYLON WEBBING

LITE WEIGHT NYLON WEBBING

Used in horse halters & pet supplies, thickness is 1.86 mm, 50 yard rolls, Surcharge applies for part rolls !
 Available in the following colors : #10-Black #11-Blue #12-Brown #13-Burgundy #14-Green #15-Silver
 #16-Hunter Green #17-Navy Blue #18-Neon Green #19-Orange #20-Pink #21-Pastel Pink #22-Purple #23-Red
 #24-Turquoise #25-Yellow #26-Beige #30-Pumkin #35-Lavender #42 Jaguar #47-Charcoal #52-Rose



Size	Item #	Colors Available
3/8"	#10-038 (plus color	
1/2"	#10-012-10	Black Only
5/8"	#10-058 (plus color #)	
3/4"	#10-034 (plus color #)	
1"	#10-100 (plus color #)	
1 1/4"	#10-114-13	Burgundy Only
1 1/2"	#10-112-13	Burgundy Only

HEAVY WEIGHT NYLON WEBBING

Used for horse harness, halters and pet supplies, thickness is approx. 2.6mm, 50 yard rolls, Surcharge applies for part rolls !
 Available in the following colors: #10-Black #11-Blue #13-Burgundy #14-Green #15-Silver #21-Pastel Pink #22-Purple
 #23-Red #24-Turquoise #26-Beige #37-Sunflower #46-Raspberry



Size	Item #	Colors Available
5/8"	#11-058 (plus color	
3/4"	#11-034 (plus color	
1"	#11-100 (plus color #)	
1 1/4"	#11-114) plus color #)	#10-#11-#14-#23
1 1/2"	#11-112-10	Black Only
1 3/4"	#11-134-10	Black Only
2"	#11-200-10	Black Only
Medium Weight		1.95mm Thickness
1"	#16-100-10	Black Only
1 1/2"	#16-112-10	Black Only
1 3/4"	#16-134-10	Black Only
2"	#16-200-10	Black Only

POLYPROPYLENE WEBBING

Used for surcingles and binding on blankets plus numerous other uses, 100 yard rolls Surcharge applies for part rolls !

Size	Item #	Colors Available
3/8"	#13-038-10	Black
1/2"	#13-012-31	White
1"	#13-100 (plus color #)	Black & White
1 1/2"	#13-112-10	Black
2"	#13-200 (plus color #)	Black, Blue, White



SEAT BELT WEBBING

Thickness is .95 mm, 100 Yard rolls.
 Surcharge applies for part rolls.

Size	Item #	Colors Available
2	#17-200-10	Black



LEATHER



PATENT

A heavy finished chrome tanned leather with high gloss finish. For use on show harness etc. Sold by the square ft.
#483-BK 8/9 oz Black 20-22 sq. ft.

SOLE

These sole bends are cut from the best portion of the hide and tanned for extra firmness and durability. Ideal for horseshoe pads and shoe soles. Sold by the pound.
#480 13/15 oz Natural 12-16 lbs 15-17 sq. ft.

WRAP

A soft, stretchy leather. Ideal for rolling pads, seats, belly band etc.. Sold by the square foot.
#487 3/4 oz Black 24-28 sq. ft.

SADDLE SKIRTING

This heavy duty skirting leather has superior strength. Tools and molds well-stocked in natural but golden and chestnut are available. Sold per pc. Also available in 11/13.
#495 13/15 oz 18-22 lbs avg. 22-24 sq. ft.

WHITE

Shiny white finished leather with pigmented finish. Used for show halters, bridles etc. Sold per square foot.
#486-810 8/10 oz 21-24 sq. ft.
#486 10/11 oz 21-24 sq. ft.

LIGHTWEIGHTS

STRAP LEATHER

Very versatile, firm yet flexible leather has many uses. Ideal for body bells, bags, pouches etc. Sold per square foot.
#492 7/8 oz 22-24 sq. ft.

APRON LEATHER

This soft suede can be used for chaps, saddle seating, pouches etc. Buckskin and dark brown is stocked but many colours available. Sold per square foot.
#491 3/4 oz 10-14 sq. ft.

GREY APRON SPLITS

Quality chrome tanned apron splits are soft, durable and consistent in weight. Grey in colour. Sold per square foot.
#591 7/8 oz 19-20 sq. ft.

LEATHER CONVERSION CHART

Ounces	Irons	Fractional Inches	Decimal Inches	Milli-meters
9 oz.	6.75	9/64	0.141	3.58mm
10 oz.	7.50	5/32	0.156	3.96mm
11 oz.	8.25	11/64	0.172	4.37mm
12 oz.	9.00	3/16	0.188	4.78mm
13 oz.	9.75	13/64	0.203	5.17mm
14 oz.	10.50	7/32	0.219	5.57mm
15 oz.	11.25	15/64	0.234	5.95mm
16 oz.	12.00	1/4	0.250	6.36mm

LEATHER

Please Note: Our aim is to supply you with the best quality leather at a reasonable price. All the following leathers we use in our own facility. If you want something that is not listed please call and we'll see if we can source it for you.



Harness

This is a good quality drum dyed leather, firm yet pliable, very easy to work with, a smooth waxy black finish, comes in backs, priced per pound. ***Buy 3 backs of one weight for a lower price***

#488-L	Light	10 oz	Avg. Weight	17-19 lbs.	Approx. Sq. Ft.	21-24 sq. ft.
#488-M	Medium	9/11 oz	Avg. Weight	19-22 lbs.	Approx. Sq. Ft.	21-24 sq. ft.
#488-H	Heavy	10/12 oz	Avg. Weight	20-23 lbs.	Approx. Sq. Ft.	21-24 sq. ft.
#488-EH	Extra Heavy	12 + oz	Avg. Weight	22-26 lbs.	Approx. Sq. Ft.	21-24 sq. ft.

We often have ass't size hide drop off pieces at a reduced price!

Russet Harness

A hot stuffed firm yet flexible light coloured leather. Ideal for harness reins, headstalls and dog supplies. Sold per pc.

#438-L	Light	10 oz	Avg. Weight	17-20 lbs.	Approx. Sq. Ft.	21-24 sq. ft.
#438-M	Medium	9/11 oz	Avg. Weight	20-23 lbs.	Approx. Sq. Ft.	21-24 sq. ft.
#438-H	Heavy	10/12 oz	Avg. Weight	21-24 lbs.	Approx. Sq. Ft.	21-24 sq. ft.
#438-EH	Extra Heavy	12 + oz	Avg. Weight	21-25 lbs.	Approx. Sq. Ft.	21-24 sq. ft.

Bridle

A well liked strong veg tanned leather, waxy finish on both sides, ideal for lines, English and Western tack. Comes in Black, English Tan and Havana. Backs only. Sold by the square ft. Other colours available.

#484-BKL	9/10 oz	Black	Approx. Sq. Ft.	16-19 sq. ft.
#484-BKH	12/13 oz	Black	Approx. Sq. Ft.	16-19 sq. ft.
#484-HL	9/10 oz	Havana	Approx. Sq. Ft.	16-19 sq. ft.
#484-HH	12/13 oz	Havana	Approx. Sq. Ft.	16-19 sq. ft.
#484-TL	9/10 oz	Tan	Approx. Sq. Ft.	16-19 sq. ft.
#484-TH	12/13 oz	Tan	Approx. Sq. Ft.	16-19 sq. ft.

Latigo

A strong chrome veg retanned leather with a nice top finish. We stock black and burgundy. Sold by the square ft.

#489-MBL	8/9 oz	Black	Approx. Sq. Ft.	21-24 sq. ft.
#489-HBL	9/11 oz	Black	Approx. Sq. Ft.	21-24 sq. ft.
#489-MBU	8/9 oz	Burgundy	Approx. Sq. Ft.	21-24 sq. ft.
#489-HBU	9/11 oz	Burgundy	Approx. Sq. Ft.	21-24 sq. ft.

HAND TOOLS

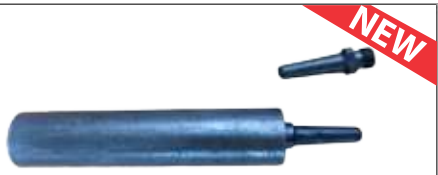

#5009 PUNCH TUBE HOLDER
• This is a handle designed to hold the #5009 punch tubes that are very sharp for cutting biothane!



#5700 ECONOMY LEATHER PUNCH
Revolving leather punch.
• Nickel plated steel frame
• Size 1-6 heated treated tubes
• Tubes are not replaceable



#6600 LEATHER PUNCH
A good quality punch at an economical price.
• Made from top quality steel
• Size 1-6 Replaceable screw tubes



#6600S OSBORNE LEATHER PUNCH
Here is a highly polished steel punch.
• Made from top quality steel
• Tubes, anvil and springs are replaceable



#6602 COMPOUND LEATHER PUNCH
A revolving punch that requires 70% less power than your average punch.
• Punch tubes are not replaceable



#510-H LEATHER SKIVER
This skiver is great for lap or level skiving.
• Features a 6" precision ground blade
• Handle adjustment
• Adjustable stop can be set for repeated level skiving



#510-PRO LEATHER SKIVER
Patterned after the old Osbourne 84 model.
• Extra heavy duty 8" hardened and ground blade
• Twist handle setting for precise leveling or lap skiving
• Made to last a lifetime



#6601 PUNCH TUBES
These are good quality, heat treated steel punch tubes for the #6600 Leather Punch.

- #6601-1 3/32"
- #6601-2 7/64"
- #6601-3 1/8"
- #6601-4 5/32"
- #6601-5 11/64"
- #6601-6 3/16"



#513 MINI PUNCH SET
A mallet punch set with changeable punch tubes.
Tube sizes range from 5/64"-3/16"



#6600T TUBES
These tubes are for the #6600S Osborne Leather Punch.

- #6600T-1 3/32"
- #6600T-2 7/64"
- #6600T-3 1/8"
- #6600T-4 5/32"
- #6600T-5 11/64"
- #6600T-6 3/16"



#515 HALF ROUND KNIFE
Popular with all types of leatherwork. Osborne model.
• Top quality forged steel blade
• Oval lacquered handle with brass ferrule
• Blade is 5" from point to point

HAND TOOLS



#5024 REIN ROUNDER

A highly polished SS rein rounder.

- Features nine holes sizes from 1/4"-3/4"
- A must for rounding reins, winkers and other leather goods
- Just fasten into vice

#5085 STITCHING HORSE

Designed for all your stitching needs.



- Keeps items securely in place with leather covered jaws
- Great for stitching saddles, harnesses and other leather products
- Durable oak frame with contoured pine seat
- Convenient foot pedal locks jaws



#500-AL DRAW GAUGE

An aluminum draw gauge with an enameled handle. Cuts leather strips up to 4" wide.



#515C Biothane/Beta cutting Scissors

Replaceable standard utility blades. A must have tool in the industry.

#596 PAD SCREW PILERS

Handy tool to turn in pad screws



#504 EDGE TOOL

This Bissonette safety edger can be pushed or pulled to bevel edges. Osborne model.

- #504-0 Size 0 5/64"
- #504-1 Size 1 3/32"
- #504-2 Size 2 7/64"
- #504-3 Size 3 9/64"



#505 HAND CREASER

Single edge creasers. Place long side of tool against edge of leather as a guide and make impression with the short side. Round edges with edge tool before using creaser. Osborne model.

- #505-2 Size 2
- #505-4 Size 4



#506 OVERSTITCH WHEEL

Marks leather for stitching look. Osborne model.

- #506-5 5 Stitches per inch
- #506-6 6 Stitches per inch
- #506-7 7 Stitches per inch



#593A ADJUSTABLE GROOVER

A top quality leather groover with edge guide.

- Harden tips make this a long lasting tool
- Adjusts from 1/16"-1"
- Available for right or left hand



#593-NA LEATHER GROOVER

A non adjustable leather groover.

- Harden tips make this a long lasting tool
- Works great for those curves and fancy grooving
- Mounted on a plastic handle



#499 LEATHER GROOVER

An economy leather groover

- Adjustable with a set screw
- Smooth wooden handle
- Has a replaceable tip

HAND TOOLS



#1280 TAPERED LOOP IRONS

- Eight sizes are included in the set 3/8"- 1 1/4"
- These irons are 10" long and have holes drilled for easy hanging
- Size is stamped on
- Can be bought separate or as a set
- 1 1/2", 1 3/4", 2" are also available



#1281 THIN LOOP IRONS

- Eight sizes are included in the set 1/2"-1 1/2"
- These loop irons are used for shaping sewn loops of harness parts
- These loops are 3/16" thick on the 1/2", 5/8", 3/4"
- Size 7/8" and larger are 1/4" thick
- Can be bought separate or as a set
- 1 3/4", 2" are also available



#507 DYE BOX

This is a handy tool for all your edge dyeing needs.

- Has a sponge roller
- Edge dyes all straight and curved patterns
- Comes with a cover to keep dye from drying out

#507-FC Replacement Foam



Great for Sharpening and Polishing Edgers!

BEST SELLER!

STROP BOARD

Easily sharpens edgers so you can edge faster and with more precision.

- Features narrow and wide leather strips on both sharpening and polishing sides to accommodate different edger size
- Wooden base measures 5 1/4" x 14" and features a plastic divider to keep sharpening and polishing strips separate
- You'll need one of the following: beeswax (adheres aluminum oxide to strip), aluminum oxide (sharpens the edger), and jeweler's rouge (polishes the edger)

- #5111 Strop Board
- #5112 Aluminum Oxide 6 oz.
- #5113 Jeweler's Rouge 6 oz.
- #5114 Beeswax 1 oz.



#5089S ELECTRIC HOT KNIFE

- We use this cutter in our shop and find one of the best on the market!
- Comes with a 5" stainless steel blade
- Adjustable Heat control, 110 volt
- **Always use an exhaust suction blower when using this machine !!!**



MAGNETIC TOOL BAR

An easy solution for those tool strewn work benches. Fastens anywhere with only 2 screws.

- #5083-24 3 PC Tool Bar Set



#5087W THERMAL HANDLE

A great tool for sealing holes, slots and ends in Biothane, Granite and Nylon webbing.

- Tip is changeable.
- 80 watt.

#5087W TIPS

These tips are for the above thermal heating handle.

- #5087W-532 3/32" Hole Tube
- #5087W-316 3/16" Hole Tube
- #5087W-732 7/32" Hole Tube
- #5087W-14 1/4" Hole Tube
- #5087W-TS Solid Tip



#5088 HOLDER FOR THERMAL HANDLE

- Screws onto workbench or wall

HAND TOOLS



#508 HOLE PUNCH

Steel Osborne hole punch. Punchings clear themselves automatically through the side barrel.

- #508-316 Size 3/16"
- #508-14 Size 1/4"
- #508-516 Size 5/16"
- #508-38 Size 3/8"
- #508-716 Size 7/16"
- #508-12 Size 1/2"
- #508-58 Size 5/8"



#5115 BAG PUNCH

A high quality bag or oblong punch. Taper clearance. Polished barrel. Hardened and polished edge.

	Size	Width
#5115-38	3/8"	3/32"
#5115-12	1/2"	7/64"
#5115-58	5/8"	1/8"
#5115-34	3/4"	9/64"
#5115-1	1"	5/32"
#5115-114	1 1/4"	1 1/64"
#5114-112	1 1/2"	13/64"



#5116 STRAP END PUNCH

A high quality pointed strap end punch. Hardened and polished edge.

- #5116-12 Size 1/2"
- #5116-58 Size 5/8"
- #5116-34 Size 3/4"
- #5116-1 Size 1"
- #5116-114 Size 1 1/4"
- #5116-112 Size 1 1/2"
- #5116-134 Size 1 3/4"



#5117 ROUND STRAP END PUNCH

A high quality round strap end punch. Hardened and polished edge.

- #5117-12 Size 1/2"
- #5117-58 Size 5/8"
- #5117-34 Size 3/4"
- #5117-1 Size 1"
- #5117-114 Size 1 1/4"
- #5117-112 Size 1 1/2"
- #5117-1 3/4 Size 1 3/4"



#463 RIVET SETTER

Hand sets tubular rivets with ease

- Has a splash anvil with knurled handle
- Includes 50 assorted rivets



#512 RIVET AND BURR SETTER

Sets copper rivets and burrs.

- A heat treated precision-made tool
- Face edges slightly rounded to reduce prints on leather

- #512-8 #8 Rivets
- #512-9 #9 Rivets
- #512-10 #10 Rivets
- #512-12 #12 Rivets



#517 SPOT SETTER

Aluminum die cast tool.

- Will adjust from 1/4" - 1"
- Has a 3" handle

#517B Replacement Blades.



#5171 SPOT SETTER

Sets one spot at a time with a hammer with this setter. Available in 1/4", 5/16", 3/8", 1/2", 5/8"



#608 GROMMET SETTER

For inserting sheet brass grommets with washers.

- #608-0 Size 1/4"
- #608-1 Size 5/16"
- #608-2 Size 3/8"
- #608-3 Size 7/16"
- #608-4 Size 1/2"



#5086 MALLET

A premium quality mallet that is well balanced.

- Durable nylon heads stand up to heavy duty use
- Contoured leather handle that is very comfortable for the hands

- 16 oz.** 2" Striking surface
- 24 oz.** 2 1/2" Striking surface
- 32 oz.** 2 1/2" Striking surface
- 48 oz.** 3" Striking surface
- 64 oz.** 3" Striking surface



#498 TACK PULLER

A great tool for pulling tacks.

TOOLS



#5050 ADJUSTABLE BACK STOP
A handy guide to set spots, etc.



#5022 DIAMOND SPOT SETTER
A tool to set diamond spots. Is available in 1/4", 3/8", 5/8", 3/4" and 7/8".



#5060 ROUND SPOT SETTER
This attachment is designed to spot any size spot accurately. Comes as a 3 piece set but all pieces can be bought separately. A semi automatic spot setter is also available.
• 1/8", 3/16", 1/4", 5/16", 3/8", 1/2", 5/8" and 3/4"



#5069 HEX SPOT SETTER
For use with the hex spots (#207).
• 1/2" and 3/4"

PLEASE NOTE :
These are only a few common attachments. If needing tooling to do a certain job, contact us on availability.



#5012 SLOT PUNCHES
An easy way to slot your straps, etc. Available in 1/2", 5/8", 3/4" and 1".



#5028 GROMMET SETTER
Will set the #240 grommets with a plain washer.
• Sizes 00 up to 5



#5006-H NYLON PAD HOLDER/PAD
A simple holder to hold nylon cutting block in place. Can be used with hole, slot or end punches.
#5006-NP Replacement nylon cutting blocks.



#5014 STRAP END PUNCH
Makes a nice clean strap end. Available in 5/8", 3/4", 1", 1 1/4" and 1 1/2".



5117M Round End Strap Punch
Available in;
- 1/2" - 1 1/4"
- 5/8" - 1 1/2"
- 3/4"
- 1"



SNAP FASTENER SET
#5020 4 Pc Line 20 Snap Fastener Set
#5021 4 Pc Line 24 Snap Fastener Set

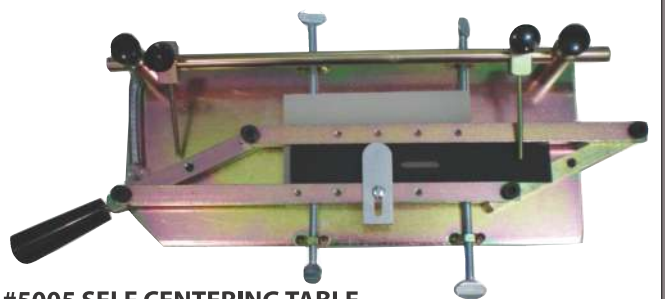

#5005 SELF CENTERING TABLE
Very handy to fasten onto machine. Handy finger guides that tighten anywhere on round rod, can be used when making holes for accurate spacing. A spring loaded self closing affair, automatically centers your strap from 3/8" - 3" wide. Front bar can be removed to use #5014 strap end punch if you like.

TOOLS



#5000 PUNCH MACHINE

This foot operated, compact, versatile machine does many different jobs for any harness, saddle or shoe shop. Tooling can be changed in minutes. Machine comes unassembled for easy shipping. Weight is approx. 100 lbs. Stands 55" high and is easily assembled. Comes with 8 pocket tray.



#5100 BENCH MOUNTED HAND PRESS

This machine mounts easily onto your work bench. Is hand operated and will take all the same tools as above machine.



#5076 SLIDE LOOP ASSEMBLY

Will take loops from 1/2" to 3". Uses #123 stables.



HOLE PUNCH SET

#5010

Tube Holder Only

#5011 Anvil

#5009 Gang Punch Tubes.

Available in 1/16", 5/64", 3/32", 7/64", 1/8", 5/32", 11/64" and 3/16"



#5008 BOX LOOP ASSEMBLY

Make your own loops for your blinds or large loops. Will do up to a 9 1/2" loop. Uses #124 stables.



TUBULAR RIVET ASSEMBLY

#5016

5/16" Rivet Head Size

#5017

3/8" Rivet Head Size
Anvils sold separately.



#5016-A RIVET ANVIL

A 6-point star anvil for use on the #5016 and #5017 attachments.



#5003 ADAPTER

This is needed on some tooling that has 3/8" stems instead of 5/16". Please ask when ordering what is needed.



#5018-A RIVET CAP ANVIL

Cap anvil for use with the #5016 & #5017 attachments.

SEWING SUPPLIES



NYLON SEWING THREAD

Size #69S Black ,White, Beige
Size #69 Red, Green, Lt Blue, Navy Blue, Pink, Pumkin, Silver, Sky
Size #92 Black, White, Blue, Red, Green & Chestnut,
Size #138 Black, White, Blue, Green, Red, & Chestnut
Size #207 Black, White & Chestnut
Size #277 Black, White & Henna
Size #346 Black, White, Chestnut & Henna **Size #415** Black, White & Brown *Please note: If needing a colour not listed, ask as we can source it for you!*

Recommendation chart for machine operator.

Tells what size of thread to use with certain size needles

Needle Size	Thread Size
#250	#415
#230	#346
#200 or #25	#277
#180 or #24	#207-#138
#160 or #23	#138
#140 or #22	#99
#130 or #21	#92
#125 or #20	#69



SEWING MACHINE NEEDLES

Style	Sizes
#135 x 17	120, 130, 140, 160, 180, 200
#794	160, 180, 200, 230
#794LR	160, 180, 200, 230
#328N	160, 180, 200, 230
#328LR	160, 180, 200, 230

PEARSON MACHINE NEEDLE

(also fits Landis #1)

#331LR 200, 230

Please note: If needing a needle not listed, ask as we can source it for you!



#4602 HAND SEWING THREAD

- Waxed polyester left twist thread
- Great for hand stitching purses, chaps, pouches and other leather items
- White, Black or Brown
- 4 oz spool

HAND NEEDLES

Great for doing those small repair jobs.

#460-S Small 2 1/8" Long

#460-L Large 2 1/2" Long



#501 AWL HANDLE

A popular sewing awl shaft. Osborne brand.

- Knobbed end prevents slipping
- Nicely varnished handle
- Wrench is included



#1288 SPEEDY STITCHER

Can be used to stitch any heavy material. A very handy tool to have around the house, farm or camp.

- Comes with 1 straight and 1 curved needle
- And 1 refillable bobbin.

#1289 Straight Needle

#1289-C Curved Needle

#1289-B Bobbin w/Thread



#1290 SEWING AWL

Includes one spool of thread, wrench and instructions.

- Needle and wrench are stored in the hollow handle
- Sews a lock stitch like a machine

#1290-F Fine Needle

#1290-H Heavy Needle

#1290TR-BK Black Thread Refill

#1290TR-BR Brown Thread Refill

#1290TR-WH White Thread Refill



AWL BLADES

These blades are for the above awl.

#502 2 1/2" Blade

#503 3 Blade

MASTERTOOL MACHINERY & EQUIPMENT



65-6410 MULTIFUNCTION FOOT PRESS

- Easy to Assemble and Operate, this Weaver Leather Exclusive Performs 16 functions
- Automatic Feed Riveter attachment increases your productivity with a timesaving feed hopper that accommodates approximately 200 rivets.
- Simply dump rivets in hopper and you're ready to go without the need to insert rivets individually.
- Easy installation of automatic feed riveter attachment by simply sliding on machine and tightening down thumb screw.
- Designed and made by Weaver Leather with a solid steel, not casted,

construction for added durability.

- Foot pedal features three height adjustments for comfortable operation.
- Many of the parts for the Heritage® Foot Press will also work on this machine.
- Our design team is working on more automated attachments to make this machine even more versatile. Look for them in the near future!



#65-3075 4 TON HAND CLICKER

- Stop the tedious process of cutting patterns by hand with this hand-operated machine that's sure to save you lots of time
- This machine will pay for itself in no time with just your time savings alone
- Made by Weaver Leather, this machine gives you professional results for products you can sell at higher profit margins
- Swivel-away clicker head allows you to see where you're setting the die and offers easy clicking
- A large 3" cam and 29" long handle

gives you added leverage for easier clicking

- Knurled adjustment knob makes it easy to adjust machine for using 3/4" to 1-1/4" dies
- An aluminum plate attached to the head allows you to use double-edged dies
- Heavy-duty design is reinforced at stress points for years of dependable service
- Machine is 15" W x 10" D x 43" H (with handle extended)
- Clicker board measures 8-3/8" x 11-7/8"
- Includes mounting hardware for attachment to your workbench



65-3085 HAND OPERATED STRAP CUTTER

- Perfect for smaller cutting projects, this machine will save you time
- Gives your straps, from belt blanks to strap goods, a uniform and professional appearance
- Designed and manufactured by Weaver Leather for reliable performance
- Its 8" design features a table and roll that adjust together
- Handle can be mounted in two positions; one for higher torque, lower speed applications and one for lower torque, higher speed applications
- Thoughtfully-designed for easy access and maintenance
- Roller bearings provide trouble-free operation
- Can be portable or mounted to a workbench
- Ends remove easily for quick changes of blades and spacers
- Has the ability to cut 1/8" laces with the use of the 1/16" spacers between the blades
- Comes set-up for 1" straps with eight 1" spacers and eight blades
- An economical alternative to cutting by hand

MASTERTOOL MACHINERY & EQUIPMENT



#65-3080 LEATHER SPLITTER

- Designed to easily split almost any weight of leather down to your desired thickness, this convenient hand crank splitter has an 8" hollow ground blade for precise, even splitting
- An adjustment lever accommodates almost any leather thickness (3 oz.-14 oz.)
- Roller bearings provide long life and dependability
- Ready to mount on your workbench
- Specially-designed by Weaver Leather to provide you with years of dependable service
- Includes a blade positioning device and instruction sheet



#65-6695 8 TON HAND CLICKER

- Designed and made by Weaver Leather, this machine features dual cam action and a 39" long handle for increased leverage and almost effortless clicking
- Comes complete with its own stand for ergonomic clicking at just the right height
- Knurled adjustment knob makes it easy to adjust machine for using 3/4" to 1-1/4" dies
- With a 12" x 15" swivel-away clicker head and a 12" x 24" clicking surface, this machine accommodates larger pieces of leather and material
- Heavy-duty machine is reinforced at stress points for years of dependable service
- Minimal assembly — simply insert a couple of bolts and you'll be set up and running in no time
- Measuring 46" high without handle, this machine fits in just 24" x 32" of floor space
- Can be moved by two people. No forklift necessary
- Weighs approximately 370 lbs. including shipping crate
- FOB Wallenstein, ON



See Page 102, 103 for Attachments

#65-6650 LITTLE WONDER Riveter / Hand Press

- Compact, patented design sets snaps, rivets, caps, crystals, spots and grommets quickly, easily and professionally
- A must-have on your workbench, this machine will increase your precision and productivity
- Unique cam action arm gives you added leverage so you can operate with just one hand, reducing stress and fatigue
- Designed and manufactured by Weaver Leather for dependability and performance
- Hand-operated design allows you to rivet faster and with more precision than any other hand-operated machine on the market
- Compact design is economically priced
- Fully assembled and ready to be mounted on your workbench
- Includes a driver and splash anvil for setting #104 Rivets
- Die sets, drivers and anvils for other rivets and snaps sold separately
- Crystal setter, grommet setter and spotter attachments sold separately
- Measures 3"W x 6"D x 18 1/2"H (including 15" long handle)
- Instruction sheet included
- U.S. Design Patent #D632,318

#65-6905 NYLON HOT CUTTER



- Must be used with one of the following attachments (all sold separately): Blocks for Cutting, Hole Punching and Poly Rope End Sealer
- An easy, effortless way to cut or punch webbing
- Holder can be adjusted at any angle to align cutter blade, giving you miter capability
- Electrical coupler on the variable heat control allows you to quickly and easily plug the cutting, hole punch and poly rope sealer attachments (all sold separately) in and out
- Catch tray neatly catches slugs to keep your work area neat and tidy
- Cuts and seals the webbing in one easy step
- Easy-to-remove self-centering guide makes centering webbing a snap
- Cutting surface is protected with Teflon® tape
- Attachments
- #65-6910 Cutting Blade Heating Block**
- #65-6911 5-Hole Tube Punch Heating Block**
- #65-6913 Poly Rope End Sealer & Cooling Block**

Expand Little Wonder's Capabilities with the Right Attachments for Your Needs

Attachments

- 65-6455** Cap Anvil for #104 Rivets
- 65-6165** Magnetic Driver with Anvils
- 65-6166** Magnetic Driver without Anvils
- 65-6662** Crystal Setter Attachment, 5/16"
- 65-6665** Spotter Attachment,
1/8", 3/16", 1/4", 5/16", 3/8" or 1/2"
- 65-6664** Anvil for Spot Setter Attachment,
1/8", 3/16", 1/4", 5/16", 3/8" or 1/2"
- 65-6667** Grommet Setter Attachment, #00
- 65-6667** Grommet Setter Attachment, #0
- 65-6667** Grommet Setter Attachment, #1
- 65-6667** Grommet Setter Attachment, #2
- 65-6667** Grommet Setter Attachment, #4

Gang Punch Tubes

- 65-6193** Threaded Punch Handle
- 65-6615** Tubes, Sizes 5-10, Thread Size .295-32 (Priced per each)
- 65-6585** Brass Anvil

Eyelet Setters

- 65-6668** Eyelet Setter, 8 mm
- 65-6668** Eyelet Setter, 10 mm
- 65-6668** Eyelet Setter, 12 mm

Die Sets

- 65-6160** 2205 Segma Snaps
- 65-6161** 2206 Snaps (#20 line snaps)
- 65-6162** 4P Durable Snaps (#24 line snaps)
- 65-6163** Double Cap, Rapid and Jiffy Rivets,
Won't Set 1/4" 2200 Rivets

FUNCTION	ATTACHMENT	DESCRIPTION
SET #104 RIVETS WITH CAP 	65-6455 Cap Anvil for #104 Rivets 	For use with the 65-6655 Driver Attachment for #104 Rivets (comes standard with machine) to set a #104 Rivet with a Cap, providing a nice, finished look on both sides
SET #104 RIVETS 	65-6165 Magnetic Driver with Anvils 	For use with plated #104 rivets only; will not work with stainless steel, nickel brass or solid brass rivets
	65-6166 Magnetic Driver without Anvils 	
SET CRYSTALS 	65-6662 Crystal Setter Attachment, 5/16" Includes Anvil	Sets 5/16" crystals to add a touch of sparkle to any project
SET SPOTS 	65-6665 Spotter Attachment, 1/8", 3/16", 1/4", 5/16", 3/8" or 1/2", specify size Includes Anvil	In combination with the 65-6664 Anvil below, this attachment sets spots with ease and precision
	65-6664 Anvil for Spot Setter Attachment, 1/8", 3/16", 1/4", 5/16", 3/8" or 1/2", specify size Replacement part for 65-6665 and 65-6662 above	Sets spots or crystals with ease and precision when used in combination with the 65-6662 Crystal Setter Attachment or 65-6665 Spotter Attachment above
SET GROMMETS 	65-6667 Grommet Setter Attachment, #00, #0, #1, #2 or #4, specify size 	Quickly, easily and professionally sets grommets on your leathercrafting projects

FUNCTION	ATTACHMENT	DESCRIPTION
PUNCH HOLES Actual Size of Hole Punch Tubes 	65-6193 Threaded Punch Handle 	Punches holes when used in combination with the 65-6615 Hole Punch Tubes and 65-6585 Brass Anvil (both shown below and sold separately)
	65-6615 Hole Punch Tubes, Sizes 5-10, Thread Size .295-32, specify size 	Punches holes when used in combination with the 65-6193 Threaded Punch Handle above and 65-6585 Brass Anvil below
	65-6585 Brass Anvil 	Used with the 65-6193 Threaded Punch Handle and 65-6615 Hole Punch Tubes (both above) when punching holes
SET EYELETS 	65-6668 Eyelet Setter, 8 mm, 10 mm or 12 mm, specify size 	Adds eyelets to your projects with ease and precision
SET SNAPS 	65-6160 2205 Segma Snaps Die Set 	Sets top and bottom of 2205 Segma Snaps
	65-6161 2206 Snaps (#20 Line Snaps) Die Set 	Sets top and bottom of 2206 Snaps (#20 Line Snaps)
	65-6162 4P Durable Snaps (#24 Line Snaps) Die Set 	Sets top and bottom of 4P Durable Snaps (#24 Line Snaps) Will also set 02207 Locking Snaps
SET DOUBLE CAP, RAPID & JIFFY RIVETS 	65-6163 Double Cap, Rapid & Jiffy Rivets Die Set <p><i>Note: Won't set 1/4" 2200 Rivets</i></p>	Sets double cap, rapid and jiffy rivets with caps

Slide Loop Setter

- 65-6671 Slide Loop Staple Setter
- 65-6672 Slide Loop Staple Setter with Loop Anvil
- 65-6673 Slide Loop Staple Setter with Spot Anvil
- 65-6664 3/8" Spot Anvil



Works with 15S4 Loop Staples on page 150

65-6673 Slide Loop Staple Setter with Spot Anvil

65-6671 Slide Loop Staple Setter

65-6664 3/8" Spot Anvil

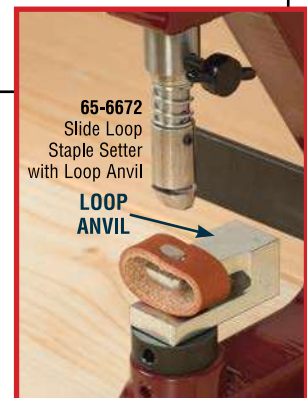

MASTERTOOL MACHINERY & EQUIPMENT



#65-6025 POWER EDGE SLICKER

- Get that professional hand rubbed look in a fraction of the time spent doing it by hand with this power slicker
- Designed to be mounted to the edge of your workbench, this machine has a 45 degree angled arm for the rolls so they come out past your bench for easier use
- Gives all sides of your leather straps a smooth finish
- Convenient motorized design
- Wooden roller is great for final touches and can be used dry
- Sanding roller is designed specifically for sanding applications



#65-6690 ROTARY PUNCH

- Designed for maximum performance and efficiency at a great price
- Even with a wide selection of power equipment to choose from, we use this machine in our shop all the time because of its ease of set-up and use
- Simple, trouble-free design allows you to punch self-centering holes or punch holes down the side of a strap with the addition of our optional offset guide
- The only hand-operated machine of its kind on the market, it will boost your productivity
- A clicker board anvil offers more effective punching
- Dual feed design helps feed material through machine
- Accommodates straps from 1/2" to 3" wide
- Punches clean holes from 1/2" to 3-1/8" apart
- Adjustable setting for hole spacing and leather thickness
- Measures 16" W x 10" D x 16" H
- Includes six tubes in sizes 2, 4, 5, 6, 7 and 8

#65-6680 SELF CENTERING PUNCH

- Self-centering design ensures professional, accurate results every time
- Accommodates up to 11" long dies
- Accommodates straps from 1/2" to 3" wide
- Hand-operated machine gives you the versatility to perform a wide range of punching projects simply by changing out your die
- A large 3" cam gives you increased leverage
- Designed and made by Weaver Leather for years of dependable performance
- Punches slots, holes and points into any belt blank with one easy stroke
- Measures 13" W x 12" D x 38" H (including the handle)



PEARSON SEWING MACHINE PARTS

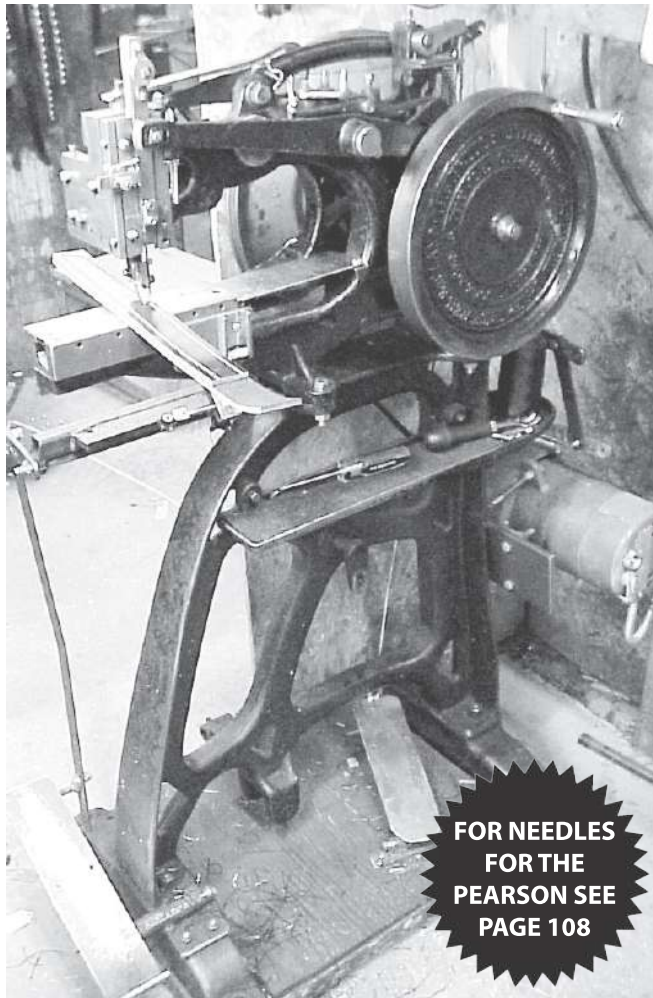

FOR NEEDLES FOR THE PEARSON SEE PAGE 108

PEARSON SEWING MACHINES

These machines haven't been made for many years. Some are over 100 years old and still going strong! They are a harness and saddler maker's favourite. We custom repair and refurbish plus buy and sell these machines.



#650 PEARSON SHUTTLES

Finally we now make and stock the shuttle that was so hard to find before.

- Tested and hardened to last
- Has same shape as the original
- Smoothly finished to work nicely.

- #650C Complete with side spring and bobbin
- #650B With side spring and bottom spring less bobbin.



#131P BOTTOM NEEDLE GUIDE PLATE



#154P TOP NEEDLE GUIDE PLATE



#80CF PEARSON CLAW FOOT



#94P PRESSER BAR TOGGLE PLATE



#325E STITCH LENGTH ARM SPRING



#324E FOOT LIFT SPRING



#461 PEARSON BOBBIN



#147TS BOBBIN SPRING
• Comes with rivets.



#92SP FOOT PRESSURE SPRING



#560-FS PEARSON FOOT SCREW



#459AS NEEDLE CLAMP SCREWS

#426D DRILL & TAP SET
Drill and tap set to modify the original Pearson for the #459AS needle clamp screws.



#458 THREAD TENSION SPRING
• With screws

PEARSON SEWING MACHINE PARTS



Guide
Edge
Roller

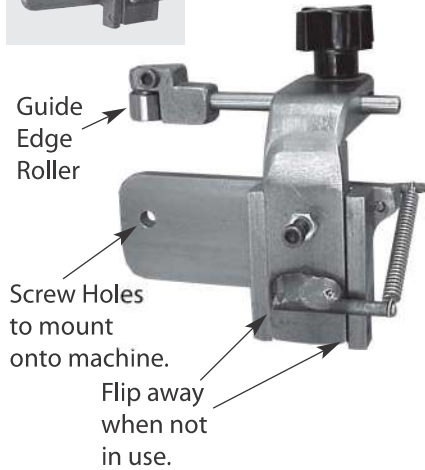

Screw Holes
to mount
onto machine.

Flip away
when not
in use.

**#462P PEARSON SEWING MACHINE
EDGE GUIDE**

It's here. An edge guide so versatile yet so completely out of the way when turning your work around or when not in use. Just flip it up or down as needed.

- Heavy duty

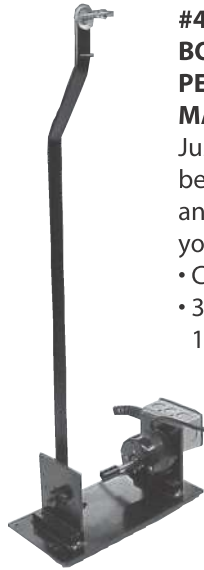

**#451 ELECTRIC
BOBBIN WINDER FOR
PEARSON SEWING
MACHINES**

Just what you have been waiting for, a fast and easy way to fill your bobbins.

- CSA approved
- 3' cord to plug in a 115 receptacle

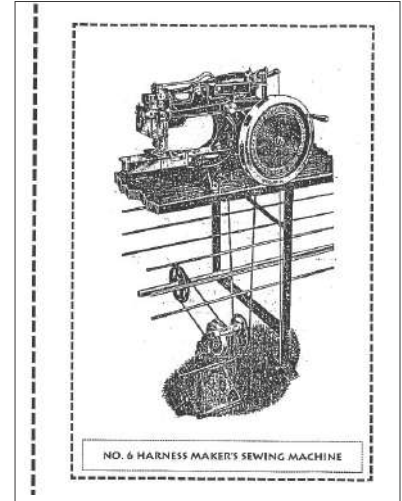

#509 PEARSON MANUAL

#451-H BOBBIN WINDER

Hand cranked bobbin winder. A quick, easy way to fill those Pearson bobbins.



#P-562 NEEDLE GUIDE

- Needle guide for Pearson sewing machines
- Made of steel.



**#P-568 BOTTOM THREAD TENSION
PLATE**



**#P-567 TOP THREAD TENSION
PLATE WITH SCREW**



**#P-565 SHORT STEM ROLLER CAM
FOLLOWER FOR NEEDLE BAR ARM**



**#P-564 LONG STEM ROLLER CAM
FOLLOWER FOR SHUTTLE ARM**



**#P-563 SHUTTLE COVER SPRING
WITH SCREW**



**#P-570 BOTTOM THREAD LOCK
PLATE**



#P-566 TOP THREAD LOCK PLATE

SEWING SUPPLIES

SCISSORS SHARPENING SERVICE AVAILABLE
SEND YOUR SCISSORS OR KNIVES IN AND WE WILL GET THEM SHARPENED



#5180 LED MAGNETIC SEWING MACHINE LIGHTS

These lights are very bright and stick to your machine upside down and shine directly on material that you are sewing.

- 110 volt or 12 volt
- Comes complete with cord and switch



#5179 Sewing Machine Light W/Flex Arm

Very nice, bright light, attaches magnetic, plugs into 110V. Ideal for applications where you move the light around.



#496 HAND SCISSORS

A good quality scissors for light leather and tough materials. Polished stainless steel.



#496H SCISSORS

An 8 1/4" heavy duty scissors that cuts biothane, leather and nylon with ease.



SEWING OIL

A good quality sewing oil for all industrial machines.

- #466 4L jug
- #466 1L jug



#5092 Thread Burner

A great way to melt your thread ends.

- Uses 4 AA batteries
- 8 1/2" overall length



#467 THREAD NIPPER

An economy thread nipper. 4 3/4" overall length.



#468 PRO THREAD NIPPER

A very high quality thread nipper for every day professionals. Stainless steel with a ball bearing. 4 1/2" overall length.



PLASTIC PARTS BIN

A handy bin to store your hardware or other items. Each bin comes with a divider.

- #5071 Small 4"L x 3 1/2"W x 3"D
- #5073 Medium 6"L x 3 1/2"W x 3D
- #5075 Large 9"L x 5"W x 5"D



#465 OILING BOTTLE

A long nozzle sewing machine oil bottle.

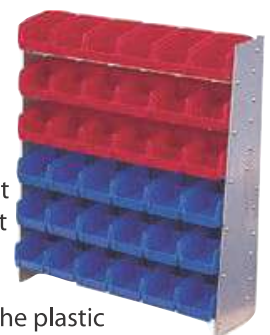

ORGANIZER BINS

Here is a great organizer unit for any shop.

- Galvanized frame with the plastic parts bins.
- #5070-2 Tray 6 Sm. & 6 Med.
- #5072-4 Tray 12 Sm. & 12 Med.
- #5074-6 Tray 12 Sm. & 12 Med. & 12 Lg.

MILITARY/LIVERPOOL/BUXTON BITS/CURB CHAIN

WARNING: Military and Liverpool Bits Prove to be Unsafe With Snaps.
If using snaps, use #290WS as these are designed for this use.



#850R SLOT MILITARY BIT
• BR or CHR – 5 1/2", 6", 6 1/2", 7"
• POL SS – 5 1/2", 6 1/2", 7"



#850E EGGLOOP MILITARY BIT
• BR or CHR
• 5 1/2", 6", 6 1/2", 7"



#850P PORT MILITARY BIT
• POL SS
• 5 1/2", 6", 6 1/2"



#775R LIVERPOOL BIT
• BR, CHR – 4 1/2", 5", 5 1/2", 6", 6 1/2", 7"

#775RW LIVERPOOL BIT
• POL SS
• 4 1/2", 5", 5 1/2", 6", 6 1/2", 7"



#800P PORT MOUTH BIT
• POL SS
• 5", 5 1/2", 6" & 6 1/2"
• Also available in 3 loop



#800M MULLEN MOUTH BIT
• POL SS
• 5", 5 1/2", 6" & 6 1/2"
#803M is 3 loop



#800J FRENCH SNAFFLE BIT
• POL SS
• 5", 5 1/2", 6" & 6 1/2"
• Also available in 3 loop



#778J JOINTED LIVERPOOL BIT
• POL SS
• 5", 6", 6 1/2"



NEW

4808 Beta Bit
A unique idea to not have any metal through the mouth. Heavy nylon liner for extreme strength with Beta covering. Try it on your puller.



#773R LOOSE RING LIVERPOOL BIT
• SS 5 1/4", 6", 6 1/4"
• Ribbed Mouthpiece



#779S SLOT CHEEK LIVERPOOL BIT
• SS
• 5", 5 1/2", 6", 6 1/2"



#778H HEAVY LIVERPOOL BIT
• BR, CHR or SS
• 5", 5 1/2", 6", 6 1/2", 7"

#778L LIGHT LIVERPOOL BIT
• BR or CHR
• 4", 4 1/2", 5"
• SS
• 4 1/2"



NEW

4811 Puller Spring Bit With Rubber Mouth
Very good feedback for driving pullers.



#779R ROUND CHEEK LIVERPOOL BIT
• SS
• 5", 5 1/2", 6", 6 1/2"



#860-H CURB HOOKS
• BR, CHR, NP & SS
#860-C CURB CHAIN
• BR, CHR, NP & SS
• SS available in 9" or 11"

BITS

#59 DOUBLE WIRE TEAM BIT
• NP or SS – 6"



#53 SINGLE WIRE TEAM BIT
• NP – 6"
• SS – 6", 6 1/2"



#47 TEAM BIT
• SS – 4", 4 1/2", 5", 5 1/2", 6", 6 1/2", 7"
• POL – 5-1/2", 6-1/2"



#47J BIT
• NP, CHR, BP or SS – 6"
• NP – 4 1/2"



#73 MULE BIT
• NP – 6"



#48 STUD BIT
• BR or CHR – 6 1/2"



#76 RUBBER TEAM BIT
• Wire cable inside
• SS – 5", 6"



#4800 CONTROLLER BIT
A heavy duty bit common among pulling teamsters.
• SS – 5", 6", 6 1/2"



#6995 RUBBER BIT GUARD



#6995S RUBBER BIT GUARD WITH BURRS



#47JD EGG BUTT SNAFFLE BIT
• POL SS
• 4", 5", 5 1/2", 6", 6 1/2"



CHECK BITS



#51 STAINLESS CHECK BIT
• SS – 4", 4 1/2", 5", 5 1/2", 6", 6 1/2"
• BR – 4 1/2", 5"
• NP – 4 1/2"

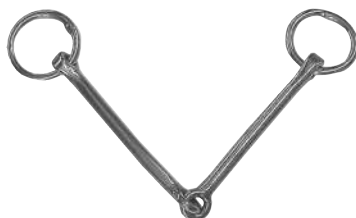

#52 JOINTED OVERCHECK BIT
• SS Polished – 5", 6"



#300 BENT CHECK BIT
• POL SS – 6", 6 1/2"

PLASTIC BUCKLES



#1022 CURVED SIDE RELEASE BUCKLES
• 3/8", 5/8", 3/4", 1"



#1021 SIDE RELEASE BUCKLES
• 5/8", 3/4", 1", 2"



#1024 STANDARD LADDERLOC BUCKLES
• 5/8", 3/4", 1", 1 1/2"



#1023 WIDE MOUTH TRIGLIDGE
• 3/8", 5/8", 3/4", 1"

DRIVING BITS



#46 MACHINED
• SS 4 1/2"-5"-5 1/2"
#46P PONY BIT
• SS 4"- 4 1/4"



#82 5" STRAIGHT RUBBER COVERED BIT
•5" Solid rod inside



#83 5" JOINTED RUBBER BIT
• SS



#975 REGULATOR JOINTED BIT
• 5" Pol SS with Leather Covering



#46MJ JOINTED MINIATURE BIT
• NP or SS
• 3 3/4"
#46J JOINTED STEEL



#47JC Copper Snaffle
• Copper mouth piece with SS rings
• 5" only

NEW



#4807 PEE WEE BIT
The Pee Wee is the only bit with a floating mouthpiece
Sizes: Medium, Large



#90 SIMPSON BIT
• SS
• 5 1/2"

#46PJ JOINTED PONY BIT
• CHR, BP or NP
• 4"
• SS
• 4 1/2"



#46R RUBBER COATED DRIVING BIT

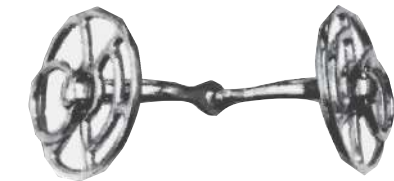

#88 BEERY BIT
• SS
• 5", 5 1/4"



#4801 HALF CHEEK HAPPY MOUTH
• A unique apple scent that horses love
• Soft, gentle, flexible and long lasting
• Stainless Steel core
• In 5" only



#840 TWISTED WIRE BIT
• A 4 ring half cheek wire bit
• Brass wire with SS rings
• 4 1/2" and 5"



#84 DOUBLE TWISTED WIRE BIT
• POL. SS
• 5"





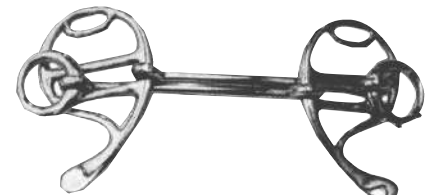

















#84S SINGLE WIRE TWISTED BIT
• POL SS
• 5"

















#89 J.I.C. BIT
• SS
• 5", 5 1/4", 6", 8", 10"





















MISCELLANEOUS SNAPS

 <p>#017 SWIVEL SNAP • BR or CHR • 5/8", 3/4", 1"</p>	 <p>#018W SWIVEL SNAP • NP ZDC • 1/2", 5/8", 3/4", 1"</p>	 <p>#018R SWIVEL SNAP • NP ZDC • 3/8", 5/8", 3/4"</p>	 <p>#224 BABY SWIVEL SNAP • BR – 1/2" Loop, 1 5/8" Long</p>	 <p>#225 ROUND EYE SWIVEL SNAP • BR – 3/8", 1/2", 5/8", 3/4", 1" • NP – 3/4", 1", 1 1/4" • SS – 3/4", 1", 1 1/8", 1 1/4"</p>
 <p>#297 BULL SNAP • NP or SS • 4" Long, 7/8" Eye</p>	 <p>#297S SQUARE EYE BULL SNAP • NP – 1"</p>	 <p>#297T BULL SNAP WITH TAB • BP, SS, NP; • 1" Round eye • SS 1" Square eye • 1" Rigid eye</p>	 <p>#297R RIGID EYE BULL SNAP • NP – 7/8"</p>	 <p>#830H HEAVY SWIVEL SNAP • NP – 3/4", 1", 7/8" SS</p>
 <p>#820 HEAVY SNAP • NP – 4" Long</p>	 <p>#252 ROUND EYE SNAP • BR • 2-1/4" O.L. - 7/16" eye • 2-7/8" O.L. - 5/8" eye • 3-1/4" O.L. - 3/4" eye</p>	<p>AN IDEAL HORSE LEAD OR STALL TIE SNAP</p>  <p>#251 SWIVEL SNAP • POL SS 7/8" Swivel Eye • 4-1/2" Long • BRASS • 3-1/4" O.L. - 3/4" eye • 3-3/4" O.L. - 7/8" eye • 4-1/2" O.L. - 1" eye</p>	<p>NEW 3/4" size</p>  <p>#297T SWIVEL BULL SNAP WITH TAB • BP, SS, NP • 7/8" Round Eye 4" long • NP • 3/4" Round eye 3-3/8" long</p>	<p>CLOSED OPEN</p>  <p>#019T TWIST PANIC SNAP • BRASS • 1" Eye Size • 4 1/4" Total length</p>
 <p>#019S SQUARE EYE PANIC SNAP • NP – 1"</p>	 <p>#019R ROUND EYE PANIC SNAP • NP – 5/8"</p>	 <p>#298W DOUBLE END SNAP • CHR or BR – 5 3/16" • SS – 5"</p>	 <p>#320 HEAVY COLD SHUT SNAP • NP – 4" Long</p>	 <p>#822 HEAVY SNAP • ZP – 4 3/4" Long</p>

MISCELLANEOUS SNAPS

 <p>#290W SNAP • BR, CHR, POL SS • 5/8", 3/4", 7/8", 1", 1 1/8", 1 1/4", 1 1/2", 1 3/4"</p>	 <p>#290 SNAP • NP • 3/4", 1", 1 1/8", 1 1/4"</p>	<p>A REAL TIME SAVER</p>  <p>#299R HALTER REPAIR SNAP • BR • 1" • removable screw</p>	 <p>#290R REPAIR SNAP W/SCREW • BR or CHR • 1", 1 1/2"</p>																
 <p>#290B BABY SNAP • ZDC NP • 1/2", 5/8", 3/4", 1" • BP – 5/8", 3/4" • BR – 5/8"</p>	 <p>#290WS SPECIAL LINE SNAP • POL SS • 1" NOTE: Will not unhook from bit while driving.</p>	 <p>#290E SNAP • BR or SS</p>	<p>#291 REPLACEMENT SNAP SPRINGS • SS for #290 Snap #291-S Small – 5/8", 3/4", 7/8", 1", 1 1/8" #291-L Large – 1 1/4", 1 1/2", 1 3/4"</p> 																
 <p>#294-L BIT SNAP • NP, large</p>	 <p>#294S BIT SNAP • BR or NP, small</p>	 <p>#293 SAFETY SNAP • NP or SS • 2", 2 1/2", 2 7/8", 3 1/4", 3 5/8", 4", 4 3/4", 5 1/2" (total length)</p>	 <p>#293G GROMMET SAFETY SNAP • NP – 2 7/8"</p>																
 <p>#299W HALTER SNAP • BR or CHR • 5/8", 3/4", 1"</p>	 <p>#299H HEAVY HALTER SNAP • BR, CHR, POL SS • 5/8", 3/4", 1"</p>	 <p>#296W TRIGGER SNAP • CHR, BR or SS • 3/4", 1"</p>	 <p>#290SH STAMPED STEEL HALTER SNAP • BP 1" • Heavy Tongue</p> <p>#265 QUICK LINKS</p> <table border="0"> <tr> <td>• NP, CHR</td> <td>• POL SS</td> </tr> <tr> <td>MAT DIA- OL</td> <td>MAT DIA- OL</td> </tr> <tr> <td>1/8 x 1 5/8"</td> <td>1/8 x 1 5/8"</td> </tr> <tr> <td>3/16 x 2"</td> <td>3/16 x 2"</td> </tr> <tr> <td>1/4 x 2 1/4"</td> <td>1/4 x 2 1/4"</td> </tr> <tr> <td>5/16 x 3"</td> <td>5/16 x 3"</td> </tr> <tr> <td>3/8 x 3 1/4"</td> <td>3/8 x 3 1/4"</td> </tr> <tr> <td>1/2 x 4 1/4"</td> <td></td> </tr> </table>	• NP, CHR	• POL SS	MAT DIA- OL	MAT DIA- OL	1/8 x 1 5/8"	1/8 x 1 5/8"	3/16 x 2"	3/16 x 2"	1/4 x 2 1/4"	1/4 x 2 1/4"	5/16 x 3"	5/16 x 3"	3/8 x 3 1/4"	3/8 x 3 1/4"	1/2 x 4 1/4"	
• NP, CHR	• POL SS																		
MAT DIA- OL	MAT DIA- OL																		
1/8 x 1 5/8"	1/8 x 1 5/8"																		
3/16 x 2"	3/16 x 2"																		
1/4 x 2 1/4"	1/4 x 2 1/4"																		
5/16 x 3"	5/16 x 3"																		
3/8 x 3 1/4"	3/8 x 3 1/4"																		
1/2 x 4 1/4"																			





























MISCELLANEOUS SNAPS

 <p>#830S SWIVEL SNAP • NP • 1"</p>	 <p>#5015W SCISSOR SNAP • BR, CHR or SS • 3/4", 1"</p>	 <p>#5013 SCISSOR SNAP • BR, CHR 1/2", 3/4" • NP 1/2"</p>	 <p>#231 COLD SHUT SNAP • NP – 2 1/2", 3 1/2", 4 1/2", 5", 6"</p>	 <p>#161D DOUBLE END SNAP • NP • 3 1/2", 4 3/4" • SS • 4"</p>
 <p>#660 JACK STRAP SNAP • BR, CHR or SS • 5 1/2" Long, 2 1/2" Ring</p>	 <p>#831 SWIVEL SNAP • NP • 1", 2"</p>	 <p>#441 BREAST STRAP SNAP • NP • 1 3/4" • w/Roller</p>	 <p>#440 BREAST STRAP SNAP • BR, CHR or SS • 1 1/2", 1 3/4" • Loose Roller</p>	 <p>#442 BREAST STRAP SNAP • BR, CHR or SS • 1 1/2", 1 3/4" • Loose Roller</p>
 <p>#447 SNAP • BR, CHR or SS • 1 1/2", 1 3/4" • w/Roller</p>	 <p>#1616W BREAST STRAP SNAP • BR, CHR, SS • 1 1/4", 1 1/2", 1 3/4"</p>	 <p>#1616 SPRING RIVET TONGUE • Repair Kit for #1616 Snap</p>	 <p>#1616 MINI BREAST STRAP SNAP • 1" Stainless steel</p>	 <p>#1616RW SNAP REPAIR • CHR or SS</p>
 <p>#290T TACKLE SNAP • SS • 1"</p>	 <p>#5016W LOCKJAW SNAP • BR 3/4", 1" • 3" Long • Swivel</p>	 <p>#253 HEAVY SHACKLE SNAP • POL SS • 7/8", 1 1/4", 1 1/2" • NP 3/4" Swivel with Roller</p>	 <p>#322 CHAIN BREAST STRAP SNAP • NP • 5 1/2" Long</p>	 <p>#321 TWIST CHAIN FOR #322 Snap • CP 20" Long • Breast Strap Chain</p>























MISCELLANEOUS HARDWARE

 <p>#68 BREAST STRAP SLIDE • SS or POL SS • 1 1/2" x 1 3/4"</p>	 <p>#62 BOLT TRACE RING • BK, BP, CHR • 1 1/2", 2", 2 1/2" • POL SS 1 1/2", 2" • Bolt/Furl</p>	 <p>#64 BOLT TRACE SQUARE • BK, BP, CHR • 1 1/2", 2", 2 1/2" • Bolt/Furl</p>	 <p>#1040H HEAVY DUTY HAME FASTENER FOR PULLING • CHR or Black</p>	 <p>#1040 HAME BINDER • CHR or Black</p>
 <p>#918 ADJUSTABLE PULLING CONNECTOR • For 2" traces • Black or SS</p>	 <p>#982 POINTED CLIP • 2-hole and 3-hole • BR, CHR, POL SS or BK</p>	 <p>#919 CONNECTOR CLIP • 1 1/4", 1 1/2", 1 3/4", 2" • BP, CHR or SS</p>	 <p>#919B BOLT STYLE TRACE CONNECTOR • Heavy duty (2" wide) • BK or SS</p>	 <p>#180 DOUBLE GRIP BUCKLE • BR • 1 1/4", 1 1/2" Traces #180W • 1 1/2" • POL SS • 2 Pc Set</p>
 <p>#983 FANCY 3-HOLE CLIP • BP, CHR or SS</p>	 <p>#989 CONCORD CLIP • 1 1/4" • BP, CHR, BK or SS</p>	 <p>#989 CONCORD CLIP • BL, BP, CHR, POL SS • 1 1/2", 1 3/4", 2"</p>	 <p>#989-5 LONG CONCORD CLIPS • 5 rivet holes (2" wide) • BK or SS</p>	
 <p>#10 or 10H BOLT TRACE DEE • 1 1/2", 1 3/4", 2", 2 1/4", 2 1/2" or 3" • BP, CHR, BK or SS</p>	 <p>#10M 1" MINI SIZE • SS or BK</p>	 <p>#63 HOOK AND DEES • 2", 2 1/2", 3" • BP, CHR, BK or SS</p>	 <p>#985W TWISTED COCKEYES • 1 1/4", 1 1/2", 2" • SS, BR or CHR</p>	 <p>#987W TRACE END COCKEYES • 1 1/4", 1 1/2" • SS</p>
<p>#66 STANDARD HEEL CHAIN • Seven link or 15 link • ZP, CP PLAIN or POL SS #66P PONY HEEL CHAIN • Seven link • CHR, POL SS or PL #66MS MINI SS HEEL CHAIN</p> 	<p>#80 HEEL CHAIN WITH SWIVEL BOLT DEE • ZP or SS – 1 1/2", 1 3/4" or 2" #80P PONY • ZP or SS – 1 1/2"</p> 	<p>GRADE 30 CHAIN #G30316 • 3/16" Dia. ZP #G3014 • 1/4" Dia. ZP #G30516 • 5/16" Dia. ZP • COMES IN 100' ROLLS • ORDER ANY LENGTH YOU NEED</p> 	<p>TRACE ADAPTERS A quick way to change your slotted traces to ones with heel chains. Made from Polished Stainless Steel. #66H-2SS 2 Link #66H-6SS 6 Link</p> 	

MISCELLANEOUS HARDWARE

 <p>#520 & 520W BUCKLE <ul style="list-style-type: none"> • 5/8", 3/4", 1", 1 1/8", 1 1/4", 1 1/2", 1 3/4" • BR, CHR or SS </p>	 <p>#4W BUCKLE <ul style="list-style-type: none"> • 3/8", 1/2", 5/8", 3/4", 7/8", 1", 1 1/8" • BR, CHR or SS </p>	 <p>#49W BUCKLE <ul style="list-style-type: none"> • 5/8", 3/4", 7/8", 1", 1 1/8", 1 1/4", 1 1/2", 1 3/4" • BR, CHR or SS </p>	 <p>#4L BUCKLE <ul style="list-style-type: none"> • 3/4", 7/8", 1", 1 1/8", 1 1/4", 1 1/2" • BR, CHR or SS </p>	 <p>#523W ROLLER BUCKLE <ul style="list-style-type: none"> • 1/2", 5/8", 3/4", 7/8", 1", 1 1/8", 1 1/4", 1 1/2", 1 3/4" • BR, CHR or SS </p>
 <p>#127R DOUBLE BAR BUCKLE <ul style="list-style-type: none"> • ZDC NP 3/8", 1/2", 5/8", 3/4", 1" • SS 1" • BP 5/8", 3/4", 1" </p>	 <p>#127 DOUBLE BAR BUCKLE <ul style="list-style-type: none"> • BR, CHR 1/2", 5/8", 3/4", 1", 1 1/4", 1 1/2" • SS 1" • NP 5/8", 3/4" </p>	 <p>#132 CART BUCKLE <ul style="list-style-type: none"> • BR, CHR or SS 1/2", 5/8", 3/4", 7/8", 1", 1 1/4", 1 1/2" </p>	 <p>#520B DOUBLE BAR BUCKLE <ul style="list-style-type: none"> • BR 1", 1 1/16" • BP 3/4" • NP 3/4" • SS 1", 1 1/4" </p>	 <p>#590 REPAIR BUCKLE <ul style="list-style-type: none"> • 3/4", 1", 1 1/4", 1 1/2" • BR <p>For quick repairs right on the job.</p> </p>
 <p>#127RR REPAIR BUCKLE <ul style="list-style-type: none"> • BP 1" • Removable screw </p>	 <p>#545W CONWAY <ul style="list-style-type: none"> • 5/8", 3/4", 7/8", 1", 1 1/8", 1 1/4", 1 1/2" • BR, CHR or SS </p>	 <p>#1025S WEB SLIDES <ul style="list-style-type: none"> • 5/8", 3/4", 1", 1 1/4", 1 1/2", 1 3/4" • BR, NP, SS </p>	 <p>#520BR DOUBLE BAR REPAIR BUCKLE <ul style="list-style-type: none"> • BP 1" • Removable screw </p>	 <p>#107W GAG WITH CONWAY <ul style="list-style-type: none"> • 5/8", 3/4" • BR, CHR or SS </p>
 <p>#10BB BELT BUCKLE <ul style="list-style-type: none"> • BR, CHR, SS, Antique BR • 1", 1 1/8", 1 1/4", 1 1/2" </p>	 <p>#325W DEE <ul style="list-style-type: none"> • 5/8", 3/4", 7/8", 1", 1 1/8", 1 1/4", 1 1/2", 1 3/4", 2" • BR, CHR or SS </p>	 <p>#323W RINGS <ul style="list-style-type: none"> • 5/8", 3/4", 7/8", 1", 1 1/8", 1 1/4", 1 1/2", 1 3/4", 2", 2 1/4", 2 1/2", 2 3/4", 3" • BR, CHR, SS or PL </p>	 <p>#255C ALL STAINLESS STEEL SEAT PAD CLIPS</p>	 <p>#1008 FOOTMAN LOOP <ul style="list-style-type: none"> • 1", 1 1/4", 1 1/2" • NP, BR or SS </p>
 <p>#106W CONWAY <ul style="list-style-type: none"> • 1/2", 5/8", 3/4", 7/8", 1", 1 1/8", 1 1/4", 1 1/2", 1 3/4", 2" • BR, CHR or SS </p>	 <p>#357W PAD BRIDGES <ul style="list-style-type: none"> • BR, CHR or SS </p>	 <p>#81 SURCINGLE BUCKLES <ul style="list-style-type: none"> • 2" size </p>	 <p>#257 REPAIR DEE WITH REMOVABLE SCREW <ul style="list-style-type: none"> • 1", 1 1/4", 1 1/2", 1 3/4", 2" • Black Steel or SS </p>	 <p>#87 SWIVELS <ul style="list-style-type: none"> • 5/8", 3/4", 1" • NP </p>
 <p>#357PWPONY PAD BRIDGES <ul style="list-style-type: none"> • BR, CHR or SS </p>	 <p>#359W OLD STYLE PAD BRIDGES <ul style="list-style-type: none"> • CHR, BR or SS </p>	 <p>#1005 CONWAY WITH LINE HOOK <ul style="list-style-type: none"> • 3/4" size • BR, CHR or SS </p>		

HARNESS DECORATIONS

 <p>#164 PONY SIZE NOSE PLATE • BR or CHR</p>	 <p>#162W HALFLINGER NOSE PLATE • BR, CHR or SS</p>	 <p>#160 DRAFT SIZE NOSE PLATE • BR or CHR</p>	 <p>#1167 SQUARE END #1165 HALTER NAME PLATE • Order your own lettering • Two lines available • Square or ornamental ends — please specify • BR or CHR</p>	 <p>#248 1/4" CAP NUTS AND BOLTS • For use on #982 and #983 clips • BR or CHR</p>		
 <p>#3 TOGGLE • Spiked or threaded • BR or CHR</p>	 <p>#3X TOGGLE • Spiked or threaded • 3/8" thread • BR or CHR</p>	 <p>#14 TOGGLE • Spiked or threaded • 3/8" thread • BR or CHR</p>	 <p>#6 PONY TOGGLE • Spiked or threaded • 3/8" thread • BR, CHR, SS</p>	 <p>#3M TOGGLE W/MAPLE LEAF • Spiked or threaded • BR, CHR, SS</p>	 <p>#1618 BELL TOGGLE • Spiked or threaded • 3/8" thread • BR or CHR</p>	 <p>#3W TOGGLE • Spiked or threaded • CHR or SS</p>
 <p>#57S THISTLE • BR or CHR • 1 1/8" x 1 1/8"</p>	 <p>#57M THISTLE • BR, CHR or SS • 1 1/2" x 1 1/2"</p>	 <p>#57L THISTLE • BR or CHR • 1 1/8" x 2"</p>	 <p>#41ML MAPLE LEAF • BR, CHR or SS • 1 1/4" x 1 1/4"</p>	 <p>#56 FRENCH ORNAMENT • BR or CHR • 1 7/8" x 2 1/2" (prongs on back)</p>		
 <p>#55 LONG SHIELD • BR or CHR • 1 1/8" x 3 1/4" (prongs on back)</p>	 <p>#50 LONG SHIELD • BR or CHR • 1" x 2 5/8"</p>	 <p>#44 SHIELD • BR or CHR • 1/2" x 1 1/2"</p>	 <p>#212 LETTERS • Entire alphabet • 1", 1 1/2", 2 1/2" height • BR, CHR or SS</p>	 <p>#16HT HORSEHEAD ORNAMENT LEFT AND RIGHT • BR, CHR or SS • 1 1/4" x 1 1/4"</p>		

MISCELLANEOUS HARDWARE

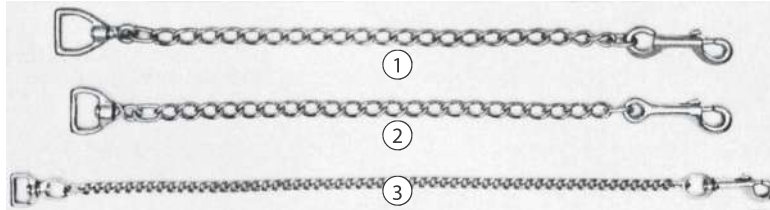

- ① **#671 Heavy (1" swivel dee)**
• 24", 30", solid BR, CHR or SS
 - ② **#670W Heavy (1" swivel dee)**
• 20", 24", 30" BP, CP (on steel)
 - ③ **#676 Flat Show (3/4" swivel dee)**
• 16" 20", 24", 30", BP, CHR (on steel), POL SS
- #676 Flat Show**
• 20", 24" Stainless Steel

 <p>#247 POINTED RIVETS • 3/16" x 1 1/2" (3/8" dia. head) • BR, CHR or SS</p>	 <p>#61 PAD SCREWS • 3/8" thread • SS or CHR</p>	 <p>#1013 WING NUT • 5/16" or 3/8" • SS or BR</p>	 <p>#12 SMALL CHECK HOOK • 5/16" thread • BR or CHR</p>	 <p>#1020 MCKINNEY HOOKS • 5/16" thread • BR or CHR</p>	 <p>#9 BUTTON HOOKS • 5/16" thread • BR, CHR or SS</p>
 <p>#86W SYRACUSE HOOKS • BR, CHR or SS (bolt included)</p>	 <p>#78 FANCY HOOK • BR or CHR</p>	 <p>#5W WIRE TERRET • 1 1/8", 1 5/8", 1 1/4", 1 5/8" in SS</p>	 <p>#79 FANCY TERRET • 3/8" thread • BR, CHR or SS</p>	 <p>#215W LOW NECK BAND TERRET • 3/8" thread • BR, CHR or SS</p>	

VERY POPULAR SHOW HARNESS CHAINS

- 13", 15", 24" Long is Standard Stock • All chain can be ordered to your length required
- Chicago screws on back for mounting.



#355RD RAISED DIAMOND CHAIN
• BR, CHR
• 5/8" Wide x 15" or 24" Length



#355 FLAT CHAIN
• POL BR, CHR
• 1/2" Wide x 13" or 24" Long, standard
• 5/8" Wide x 15" or 24" Long, standard



#355D RAISED PYRAMID CHAIN
• POL BR, CHR
• 1/2" Wide x 24" Long
• 5/8" Wide x 15" or 24" Long
• POL SS
• 1/2", 5/8" Wide x 24" Long
• Made in China



#355 FLAT CHAIN
• POL BR, CHR
• 13" or 24" Long, standard length
• Split rivets on back for mounting







HANGING DECORATIONS

 <p>#2S 1/2" LOOP • BR, CHR or SS • 1 3/4"W x 2 3.8"H</p>	 <p>#2M 5/8" LOOP • BR, CHR or SS • 2 3/4"W x 3"H</p>	 <p>#2L 3/4" LOOP • BR, CHR or SS • 2 3/4"W x 3 1/4"H</p>
---	---	---

NOTE: NO. 2 FACE PIECES SOLD SEPARATELY OR IN PAIRS

 <p>#2MM MAPLE LEAF FACE PIECE • BR, CHR or SS • 2 1/8 W x 2 3/4"H</p>	 <p>#2LM MAPLE LEAF FACE PIECE • BR, CHR or SS • 2 3/4"W x 3 1/4"H</p>	 <p>#23 3/4" LOOP • BR or CHR • 2 3/8"W x 3"H</p>	 <p>#1 3/4" LOOP • BR or CHR • 3 1/4"W x 4 1/4"H</p>	 <p>#11 HORSE 3/4" LOOP • BR or CHR • Come in pairs</p>
--	--	---	---	---

 <p>#8 HORSE SIZE MOON • 3/4" Loop • BR or CHR • 2 3/8 W x 3"H</p>	 <p>#8P PONY SIZE MOON • 1/2" Loop • BR or CHR • 1 3/4"W x 2"H</p>	 <p>#7 HORSE SIZE MOON W/STAR • 3/4" Loop • BR or CHR • 2 3/8"W x 3"H</p>	 <p>#7P PONY SIZE MOON W/STAR • 1/2" Loop • BR or CHR • 1 3/4"W x 2"H</p>
--	--	--	---

 <p>#17 FACE PIECE • 3/4" Loop • BR or CHR • 2 3/4"W x 3 1/4"H</p>	 <p>#21 BORDER SWAN • 3/4" Loop • BR or CHR • 2 3/8 W x 3"H</p>	<p>3 SIZES</p>  <p>#19 SWAN • 3/4" Loop • BR or CHR • SMALL 1 7/8"W, 2 1/2" H • MED 2 1/2"W, 2 3/4" H • LARGE 2 3/8"W, 3" H</p>	 <p>#18TH THISTLE FACE • Piece 3/4" Loop • BR or CHR • 2 3/4"W x 3 1/4"H</p>
--	---	---	--

SHOW HARNESS ORNAMENTS

CHICAGO SCREW FASTENERS ON BACK FOR EASY MOUNTING



#15 DIAMOND

• BR, CHR or SS

#	Size
15XS	5/8" x 1"
15S	7/8" x 1 1/2"
15M	1 1/4" x 2 1/4"
15L	1 3/4" x 3 1/8"



#20 HEART

• BR, CHR or SS

#	Size
20XS	3/4" x 7/8"
20S	1 1/4" x 1 3/8"
20M	1 1/2" x 1 7/8"
20L	2" x 2 1/2"



#30 SHIELD

• BR, CHR or SS

#	Size
30S	3/4" x 3/4"
30M	1" x 1 1/8"
30L	1 1/2" x 1 1/2"
30XL	1 3/4" x 1 3/4"
30J	2 1/4" x 2 1/4"



#25 SHIELD

• BR, CHR or SS

#	Size
25XS	3/4" x 7/8"
25S	1 1/8" x 1 1/2"
25M	1 5/8" x 1 7/8"
25L	1 7/8" x 2 1/2"



#35 DAISY

• BR, CHR or SS

#	Size
35S	1"
35M	1 1/4"
35L	1 1/2"
35XL	1 3/4"



#65 SHIELD

• BR or CHR
• 1 1/4" x 1 3/4"



#42 SHIELD

• BR or CHR

#	Size
42S	3/4" x 3/4"
42L	1 1/4" x 1 1/2"



#40 SHIELD

• BR or CHR

#	Size
40S	1" x 1 1/4"
40L	1 3/8" x 1 3/4"



#45 SHIELD

• BR or CHR

#	Size
45S	5/8" x 3/4"
45L	1 1/4" x 1 1/2"



#58 SHIELD

• BR or CHR
• 1 1/4" x 1 3/4"



#70 SHIELD

• BR or CHR
• 1 1/4" x 1 1/2"



#34 SHIELD

• BR or CHR
• 1" x 1 1/2"

BRIDLE ROSETTES



#24 1 1/2" RING ROSETTE
• BR, CHR
• 1 5/8" Rosette
• 1 1/2" Ring
• For Tandem Hitches



#24 2 1/2" RING ROSETTE
• BR, CHR
• 2 1/4" Rosette
• 1 5/8" Ring
• SS 2"
• For Tandem Hitches



#138 PLAIN ROSETTE
• BR, CHR 1 1/4", 2 1/4"
• POL SS 1 5/8", 2"
• BR, CHR are Heavy Cast
#138W PLAIN ROSETTE
• BR, CHR 1 1/4", 1 5/8", 2"
• POL SS 1 1/4"



#146W HORSE HEAD ROSETTE
• BR, CHR, POL SS
• 1 3/4" Rosette
• 3/4" Loop



#140R RING ROSETTE
• POL SS
• 2 1/4" 1 1/4" Loop
• For Tandem Hitches



#T163W HORSEHEAD ROSETTE
• BR, CHR, POL SS
• 2 1/4" Rosette,
1 1/4" Loop



#152 FLORAL ROSETTE
• Red Roses with Blue,
Red, Purple or White
Background
• 1 3/4" Rosette,
7/8" Loop



#148 PREMIUM GLASS HORSEHEAD ROSETTE
• Brown Horsehead
• Background Red,
Blue, Green, White
• SS Back Plate and
Loop



#133 ROSETTE
• BR, CHR
• 1 1/2" Rosette,
3/4" Loop



#140 ROSETTE
• BR, CHR, POL SS
• 2 1/4" Rosette,
1 1/4" Loop



#142 ROSETTE
• BR, CHR
• 2 1/4" Rosette,
1 1/4" Loop



#137 ROSETTE
• BR, CHR, POL SS
• 1 1/2" Rosette,
3/4" Loop



#129 HEART ROSETTES
• 1 5/8" with 7/8" loop
• POL SS



#4205 FLORAL ROSETTE
• 1 3/4" with
7/8" loop
• POL SS

Available with Chicago Screws on request



#4205B FLORAL ROSETTE W/BLACK ACCENT
• 1 3/4" with 1" loop
• POL SS



#130 ROSETTE
• BR, CHR
• 1 1/4" Rosette,
3/4" Loop



#131 ROSETTE
• BR, CHR
• 1 3/8" Rosette,
3/4" Loop

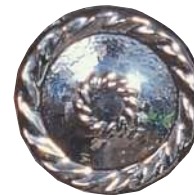





















#132 ROSETTE
• BR, CHR
• 1 3/8" Rosette,
3/4" Loop



#135 ROSETTE
• BR, CHR
• 1 3/8" Rosette,
3/4" Loop

RIVETS • SPOTS • TACKS • STAPLES









 <p>#200 ROUND SPOTS • BR, CHR • 1/8", 1/4", 5/16", 3/8", 1/2", 5/8", 3/4", 1" • 5/16" Prongs • Pol SS – 3/8", 1/2", 5/8"</p>	 <p>#1130 BARBED SPOTS • BR or CHR • 3/8", 1/2", 5/8", 3/4" (For two or more plys of leather) • 5/16" Prongs</p>	 <p>#202 DIAMOND SPOTS • BR or CHR • 3/8", 5/8", 3/4", 7/8"</p>	 <p>#1122 JEWEL SPOTS • Red, Blue, Green, Clear & gold • 1/2", 5/8"</p>
 <p>#125S STEEL TACKS SIZE #16 #19 #22 #25 LENGTH 5/8" 3/4" 7/8" 1"</p>	 <p>#125 SOLID BRASS LACE TACKS SIZE #6 #7 #7-1/2 #8 LENGTH 1/2" 5/8" 7/8" 1"</p>	 <p>#124 SOLID BRASS BOX LOOP STAPLES SIZE #5 #6 #7 #7 1/2 #8 LENGTH 5/16" 3/8" 1/2" 5/8" 3/4"</p>	 <p>#203 CLINCHER SPOTS • BR, CHR or NB • 3/8"</p>
 <p>#2032 TUBULAR RIVETS • CHR, NB or SS – 3/8", 9/16" • 3/8" dia. head</p>	 <p>#2035 TUBULAR RIVETS • BR, NB or SS – 5/16", 7/16", 9/16" • NP – 5/16", 3/8" • 5/16" dia. head</p>	 <p>#2035 TUBULAR RIVET CAP • BR or NP (to fit #2035 rivet)</p>	 <p>#123 SOLID BRASS SLIDE LOOP STAPLES • 1/4" Prong • 5/16" Prong</p>
 <p>#204 CHAIN SPOT • BR or NB • 5/8" long</p>	 <p>#246F FLORAL CHICAGO SCREW/POST • NB – 1/4"</p>	 <p>#246 CHICAGO (Screws Only) • BR or CHR • 1/4", 3/8" #246 COMBO (Post & Screw) • BR or CHR – 3/8" • NB – 1/4", 3/8" • 3/8" Combo: 1/4" Screw & 3/8" Post • 1/4" Combo: 3/16" Screw & 1/4" Post</p>	 <p>#246 (Post Only) • BR or CHR • 1/4"</p>
 <p>#243 SOLID COPPER RIVETS / BURRS • #9 x 3/8" #9 x 1" • #9 x 1/2" #9 x 1 1/4" • #9 x 5/8" #9 x 1 1/2" • #9 x 3/4" • 1 lb Boxes</p>	 <p>#243 SOLID COPPER RIVETS / BURRS • #12 x 3/8", 1/2", 3/4", 5/8", 1", 1 1/4" • 1 lb Boxes</p>	 <p>#243 ASST. ASSORTED SIZES RIVETS / BURRS • #9 x 3/4", 1", 1 1/4", 1 1/2" • Sizes are length of rivet • 1 lb Boxes</p>	 <p>#243 BURRS ONLY • #8, #9, #12 • 1 lb Boxes</p>

HAME PARTS

<p>#998 RATCHET</p> <ul style="list-style-type: none"> • For steel hames • BR, CHR or SS 	<p>#922 RATCHET</p> <ul style="list-style-type: none"> • For wooden hames • BR or CHR 	<p>#933 RATCHET</p> <ul style="list-style-type: none"> • For wooden hames • BR or CHR 	<p>#925 RATCHET</p> <ul style="list-style-type: none"> • BR • For Wooden Hames • 4 3/4" Hole Center 
<p>#926 RATCHET</p> <ul style="list-style-type: none"> • BR • For Wooden Hames • 5 3/8" Hole Center 	<p>#986 HAME BOTTOM LOOP</p> <ul style="list-style-type: none"> • 1" size • BR, CHR or POL SS 	<p>#988 HAME REPAIR</p> <ul style="list-style-type: none"> • 1 1/4" size • SS or BK 	<p>#977 HAME BOTTOM LOOP FOR PULLERS</p> <ul style="list-style-type: none"> • 1 1/4" • BR, CHR or POL SS 
<p>#999 PULLER HAME TOP LOOP</p> <ul style="list-style-type: none"> • 1 1/4" • BR, CHR or POL SS 	<p>#920 HAME SLIDE</p> <ul style="list-style-type: none"> • Small, medium, large, show • BR or CHR 	<p>#920MR REPAIR HAME SIDE</p> <ul style="list-style-type: none"> • POL SS • Medium size • For #705 Hames • Removable Bolt 	<p>#990 RING STUDS</p> <ul style="list-style-type: none"> • BP, CHR, or plain 
<p>#991 RING AND STUD</p> <ul style="list-style-type: none"> • 1 1/2" breeching ring • 2" line ring • BP, CHR or plain 	<p>#995 TRACE STUDS</p> <ul style="list-style-type: none"> • Light or heavy, thread or plain (steel) 	<p>#899 LINK AND RING</p> <ul style="list-style-type: none"> • BK, CHR or SS 	<p>#992 BREAST STRAP RING FOR STEEPLE HAMES</p> <ul style="list-style-type: none"> • Use #890 steeple • Right & Left 
<p>#890 HAMES STEEPLES</p> <ul style="list-style-type: none"> • Plain steel - 3/8" Rivet on to hame 	<p>#994 HAME BOTTOM CLIP</p> <ul style="list-style-type: none"> • With rivets 	<p>#996 ROLLER WITH WASHER</p> <ul style="list-style-type: none"> • BP, CHR, BK or POL SS • 2 1/2" or 3" long 	<p>#1000 BREAST STRAP RING</p> <ul style="list-style-type: none"> • Show, farm, puller, pony • BP, CHR, BK or POL SS 
<p>GLOBE HAME BALLS</p> <ul style="list-style-type: none"> #75P Pony size, 1 5/8" #75M Regular size, 2" #75L Extra large, 2 1/2" • BP or CHR 	<p>#75MR RING HAME BALL FOR SPREADS</p> <ul style="list-style-type: none"> • BR, CHR, POL SS • Medium • 2" Globe • 3/4" Hole, 1" Ring 	<p>#110 MINTO HAME BALL</p> <ul style="list-style-type: none"> • BR, CHR 	<p>#112 FAVOURITE HAME BALL</p> <ul style="list-style-type: none"> • BR, CHR, 









JIFFY RIVETS - HIGH QUALITY MADE IN BELGIUM

SINGLE CAPPED STYLE (EYELET OPEN ON THE BOTTOM)

							
#307S	309S	311S	407S	409S	510S	512S	

DOUBLE CAPPED STYLE (EYELET CLOSED ON THE BOTTOM)









This style gives a "finished appearance", as either eyelet or cap can be on the top or bottom.

BABY SIZE CAP 3/16"	SMALL SIZE CAP 1/4"	MEDIUM SIZE CAP 3/8"	LARGE SIZE CAP 7/16"
 7/32" #206D	 1/4"  5/16"  3/8" 307D 309D 311D	 1/4"  5/16" 407D 409D	 3/8"  7/16"  9/16" 510D 512D 515D

NUMBERS BELOW STOCKED IN BR, NB, NP, BP. ALL OTHERS BR & NB ONLY

- 407S, 407D, 409S, 409D
- BLACK - 409D

SLIDES & LOOPS

 <p>#85 SLIDE LOOPS (NOT WELDED)</p> <ul style="list-style-type: none"> • SS or POL SS • 5/8"x1/2" • 5/8"x3/4" • 3/4"x1/2" • 3/4"x3/4" • 7/8"x1/2" • 1"x3/4" • 1"x1/2" • 1 1/8"x3/4" • 1 1/4"x3/4" • 1 1/2"x3/4" 	 <p>#85 SLIDE LOOPS (WELDED)</p> <ul style="list-style-type: none"> • SS or POL SS • 3/4"x1/2" • 1"x1/2" • 1 1/8"x3/4" • 1 1/4"x3/4" • 1 1/2"x3/4" 	<p>BLACK URETHANE LOOPS</p> <table border="1"> <thead> <tr> <th>#'s</th> <th>Width</th> <th>Depth</th> </tr> </thead> <tbody> <tr> <td>06U</td> <td>1/2"</td> <td>13/64"</td> </tr> <tr> <td>07U</td> <td>5/8"</td> <td>13/64"</td> </tr> <tr> <td>07D</td> <td>5/8"</td> <td>5/16"</td> </tr> <tr> <td>08U</td> <td>3/4"</td> <td>1/4"</td> </tr> <tr> <td>08D</td> <td>3/4"</td> <td>3/8"</td> </tr> <tr> <td>09D</td> <td>1"</td> <td>7/16"</td> </tr> <tr> <td>010U</td> <td>1 1/4"</td> <td>7/16"</td> </tr> <tr> <td>011U</td> <td>1 1/2"</td> <td>1/2"</td> </tr> </tbody> </table> 	#'s	Width	Depth	06U	1/2"	13/64"	07U	5/8"	13/64"	07D	5/8"	5/16"	08U	3/4"	1/4"	08D	3/4"	3/8"	09D	1"	7/16"	010U	1 1/4"	7/16"	011U	1 1/2"	1/2"
#'s	Width	Depth																											
06U	1/2"	13/64"																											
07U	5/8"	13/64"																											
07D	5/8"	5/16"																											
08U	3/4"	1/4"																											
08D	3/4"	3/8"																											
09D	1"	7/16"																											
010U	1 1/4"	7/16"																											
011U	1 1/2"	1/2"																											
<p>#85 SLIDE LOOPS (SOLDERED)</p> <ul style="list-style-type: none"> • BR or CHR • 5/8"x1/2" • 3/4"x1/2" • 7/8"x1/2" • 1"x1/2" 	<p>#1712 RUBBER SLIDE LOOPS</p> <ul style="list-style-type: none"> • 3/4", 1", 1 1/4", 1 1/2" and 1 3/4" are made with Bio sheeting and stapled together 	<p>#1710 LEATHER SLIDE LOOPS</p> <ul style="list-style-type: none"> • 1/2" up to 2" • Black or Brown 																											
<p>VERY SOFT & PLIABLE</p> <p>#06B BIOTHANE LOOPS</p> <ul style="list-style-type: none"> #06B - 1/2 x 5/16" #08B - 3/4 x 3/8" #09B - 1 x 3/8" 	<p>NYLON RINGS</p> <ul style="list-style-type: none"> • Red, Blue or White <table border="1"> <thead> <tr> <th>#</th> <th>Size</th> <th>#</th> <th>Size</th> </tr> </thead> <tbody> <tr> <td>#0000</td> <td>7/8"</td> <td>#02</td> <td>1 1/2"</td> </tr> <tr> <td>#000</td> <td>1"</td> <td>#03</td> <td>1 5/8"</td> </tr> <tr> <td>#00</td> <td>1 1/8"</td> <td>#04</td> <td>1 3/4"</td> </tr> <tr> <td>#0</td> <td>1 1/4"</td> <td>#05</td> <td>2"</td> </tr> <tr> <td>#01</td> <td>1 3/8"</td> <td></td> <td></td> </tr> </tbody> </table> 	#	Size	#	Size	#0000	7/8"	#02	1 1/2"	#000	1"	#03	1 5/8"	#00	1 1/8"	#04	1 3/4"	#0	1 1/4"	#05	2"	#01	1 3/8"			<p>PLASTIC LOOPS</p> <ul style="list-style-type: none"> • Red, Blue, White or Black #06 1/2" #08 3/4" #07 5/8" #09 1" • Black now in nylon for added strength 			
#	Size	#	Size																										
#0000	7/8"	#02	1 1/2"																										
#000	1"	#03	1 5/8"																										
#00	1 1/8"	#04	1 3/4"																										
#0	1 1/4"	#05	2"																										
#01	1 3/8"																												

DOUBLE TREES



#1127 HEAVY DUTY WOODEN DOUBLE TREE
 • 44" or 48" Main piece that are steel bound
 • 34" or 36" Single trees w/square end hooks
 • Red or bare



#1129 HEAVY DUTY WOODEN DOUBLE TREE
 • 44" or 48" Main piece that are steel bound
 • 34" or 36" Single trees w/round end front draw hooks
 • Red or bare

#1129L HORSE DOUBLE TREE
 • 40" Main piece
 • 32" Single trees w/rear draw hooks
 • Red, Black or bare

#1129P
 • 32" Main with 24" single tree
#1129M
 • 28" Mains with 18" single tree
 Red, Bare or Varnished



#1138 WOODEN SHOW WHEEL DOUBLE TREE
 • 40" Main piece
 • 30" Single tree
 • Bare wood with CHR or SS hardware



#1139-C WOODEN SHOW LEAD DOUBLE TREE
 • 38" Main piece
 • 30" Single tree
 • Bare wood with CHR or SS hardware



#1131R HEAVY DUTY STEEL DOUBLE TREE
 • Round tube
 • 42" Main piece
 • 34" Single trees
 • Red or Bare



#1131TL STEEL DOUBLE TREE HORSE SIZE (800-1300 LBS)
 • Rectangle tube
 • 40" Main Piece
 • 30" Single trees
 • Red



#1131T-S POLISHED STAINLESS STEEL SHOW DOUBLE TREE
 • 42" Main piece
 • 30" Single trees w/safety snaps



#1131T HEAVY DUTY STEEL DOUBLE TREE
 • Rectangle tube
 • 42" Main piece
 • 34" Single trees
 • Red or Bare

SINGLE TREES & PARTS



#1128R WOODEN SINGLE TREE ROUND END
 • 34" or 36" Lengths
 • With front draw hooks
 • Red or bare



#1128S WOODEN SINGLE TREE SQUARE END
 • 34" or 36" Lengths
 • With front draw hooks
 • Red or bare



#765 CLEVIS WITH BOLT
 • 6" or 4 1/2" length
 • Red or bare



#1135 SQUARE TUBING STEEL SINGLE TREE
 • 34" Length • Red only



#1134 ROUND TUBING STEEL SINGLE TREE
 • 34" Length • Red only



#1122 DOUBLETREE MAIN PIECE ONLY
 • 38", 44" or 48"
 • Bare, Black or Red



#1120 SINGLE TREE HOOKS
 • Bare Only
 • Regular and heavy

#1120H HEAVY SINGLE TREE HOOKS
 • Bare Only



#1128-BR SINGLE TREE CENTER BRACKET
 • Bare only
 • No bolts included

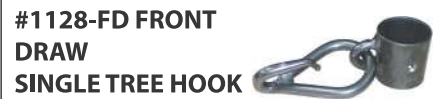

#1128-FD FRONT DRAW SINGLE TREE HOOK
 • Round end
 • Bare only



#1128-RD REAR DRAW SINGLE TREE HOOK
 • Round end
 • Bare only



#1128S-EB SINGLE TREE HOOK
 • For square end
 • Bare only
 • Hook included

NECK YOKES



#1123W-BK WOODEN CARRIAGE NECK YOKE

- 38" Long
- Leather loops with rubber center piece
- Black only



#1123L-BK STEEL CARRIAGE NECK YOKE

- 38" Long.
- Rubber center with 1 3/4" hole
- Fixed ring ends designed for snaps or breast straps
- Steel powder coated Black
- Black or stainless steel



STAINLESS STEEL NECK YOKE

- 42" Long.
- 4" Center ring
- High polished stainless steel
- #1125L-S Loop Ends
- #1125R-S Ring Ends



WOODEN NECK YOKE

#1126 DRAFT SIZE

- 42" or 48" Long
- Ring ends with 4" center ring
- Red or bare

WOODEN NECK YOKE

#1126L HORSE SIZE

- 38" Long
- Ring ends with 3 1/2" center ring
- Red or bare

1126P - Pony Size

32" Red, Varnished, or Bare

1126M - Mini Size

28" Red, Varnished, or Bare



#1133 WOODEN NECK YOKE WITH TWIN YOKES

- 40" Neck yoke with 24" twin yokes.
- 4" center ring.
- Red or bare.

#1133-SB TWIN NECK YOKE

ONLY BARE
(picture not available)

#1133-SR TWIN NECK YOKE

ONLY RED
(picture not available)

#1133-C CLEVIS FOR TWIN NECK YOKE

#1135S-RE STEEL TWIN NECK YOKE
(picture not available)



#1124R-RE STEEL NECK YOKE

- 42" Long
- Ring ends with 4" Center Ring
- Red or bare



#1124BO-RE BOLT ON STEEL NECK YOKE

- 42" Long
- Bolts onto tongue, with rings on the end
- Red



#1125R-70 4 HORSE ABREAST NECK YOKE
Also available in 3-abreast

- 70" Bottom with 2-36" top yokes
- Black or Red



#1125R-R TUBULAR STEEL NECK YOKE

- 42" Long
- Ring ends with 4" Center Ring
- Red or bare

NECK YOKE PARTS



#1125S POLISHED STAINLESS STEEL SPREADER BARS

- 38" or 42" Long
- 2 Loops on end for snaps

#1164 NECK YOKE CENTER

- Leather
- Four ply thickness
- P.V.C. inside
- #1164R
- 1" Solid Rubber
- 1" or 1 3/4" Hole



#1126-CR NECK YOKE CENTER RING

- Comes complete with plates
- Bare only



#1132 JOCKEY IRON

- 42" Long
- Comes with snaps
- Steel tube painted grey

#1175 NECK YOKE END LOOPS

- Two ply leather – 1 1/2"
- Three ply nylon



#1126-ER NECK YOKE END RING

- Bare only



EVENERS & HITCHES



#1131T-3 HEAVY DUTY STEEL 3 HORSE EVENER

- Rectangle Tubing
- Main piece
- Red or Bare



#1140 ROPE AND PULLEY TANDEM HITCH

Switch to tandem hitching to give your horses more room and comfort. Light, yet strong and durable, rope hitches make a simple and convenient hitch for all your tandem hitch needs. Our rope hitches come complete with 12' ropes, hooks, pulleys and chains. Sold by the pair which is enough for 1 horse.



#1131T-4 4-HORSE EVENER

- Heavy duty steel tubing
- 72" Main beam
- 34" Doubletree with 30" singletrees
- Red or Black



#10178 BINDER CANVAS

We also supply canvas for grain binders. Just call us with the make and we will get a price for the canvas you need.

LOGGING EQUIPMENT



#66R LOGGING HOOK
With Loop and Swivel



#66U LOGGING HOOK
With clevis and swivel

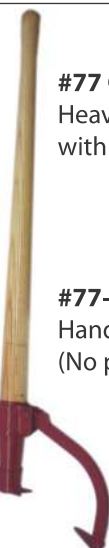

#77 CANT HOOK

Heavy duty steel construction with 40" solid ash handle.

#77-HA HANDLE ONLY

Handle for above cant hook. (No picture shown)



#67 LOGGING TONGS

High quality heavy duty forged steel construction. 34" when opened.



LOGGING CHAIN

Logging chain is 36" long with 15 links-3/8" swivel with a 2" ring.

66L Zinc Plated

66L-S Stainless Steel

CARTS



AMERICAN EASY ENTRY CART

Shown with fenders and cage which are optional. Comes with SMV sign and whip holder and flag.

#9015A MINI SIZE CART

- 20" Spoke wheels
- 56" Shafts
- 37" Overall width

OPTIONAL PARTS

- #9015A-C Luggage Cage
- #9015A-F Fenders
- #9015A-P Pole w/evener & double tree

- #9115-20 20" air tire wheels
- #9115-24 24" air tire wheels

#9016A PONY CART

- 24" Spoke wheels
- 64" Shafts
- 48" Overall width

OPTIONAL PARTS

- #9016A-C Luggage Cage
- #9016A-F Fenders
- #9016A-P Pole w/evener & double tree

CANADIAN MADE EASY ENTRY CART

#9015C MINI SIZE CART

- 20" Spoke wheels
- 50" Shafts
- 37" Overall width

OPTIONAL PARTS

- #9015C-F Fenders
- #9015C-P Pole for double driving
- Replacement Tubes and Tires available



SLEIGH RUNNERS FOR CARTS

9015A-R Runners for mini cart, 5" hub

9015C-R Runners for Pony cart

- Remove the wheels and attach the runners for winter driving
- Quick and easy to install

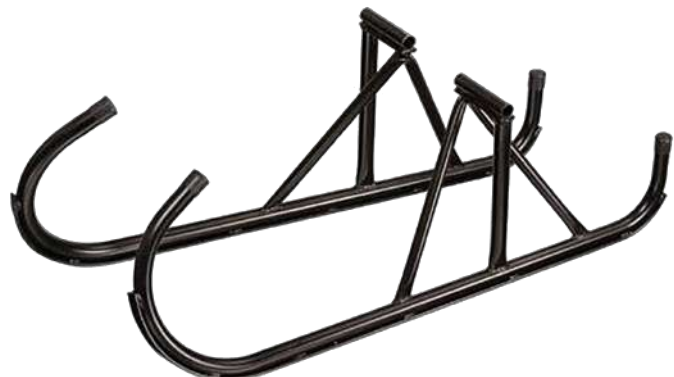



PATIO SEATS

- Bare or varnished
- Black powder coated hardware and Backs can be custom engraved



#1136-HS HAMMER STRAPS

- Black powder coated steel



1136-NP TONGUE CAP

- Comes complete with bolts
- Black powder coated steel



2058 HITCH TONGUE CAP

- For multiple hitches
- Black powder coated steel



#767 HITCH PINS

- 1/2" x 4 1/2"
- 5/8" x 6 1/4"
- 3/4" x 6 1/4"



#766 TWISTED CLEVIS

- 5/8" Twisted clevis with 1/2" pin
- Black powder Coated



2050 SAFETY TONGUE CAP

- Hitch safer with the new Pioneer Safety Tongue Cap
- No more worry of the neckyoke unhooking in normal operation
- Black powder coated steel





Mail Order Form

4445 Posey Line
 Wallenstein Ontario Canada N0B 2S0
Fax: 1.888.753.4525
Phone: 519.698.2754
Toll Free Phone: 1.800.367.0639
Email: info@aaronmartin.com
Web: www.aaronmartin.com

Shipping Address



Existing Customer Address Change

Full Name _____ Company Name (if applicable) _____
 Address Line 1 _____ Address Line 2 _____
 City _____ Prov./State _____ PostalCode: _____
 Phone: _____ Fax: _____ Email: _____

Payment Method

PayPal E-transfer COD
 Visa MasterCard AMEX

Ship Via

Canada Post UPS Other (Specify)
 Loomis Pickup _____

Credit card Number _____ Expiry Date _____ CVV code on back _____

Item number	Description	Size	Color	Qty.	Price/ea.	Total

Photocopy this blank form as often as needed **TOTAL=**
Shipping & Handling, Taxes and COD Charges are extra were applicable.



Equine & Pet Products

Mail Order Form

4445 Posey Line
Wallenstein Ontario Canada N0B 2S0
Fax: 1.888.753.4525
Phone: 519.698.2754
Toll Free Phone: 1.800.367.0639
Email: info@aaronmartin.com
Web: www.aaronmartin.com

Shipping Address



Existing Customer Address Change

Full Name _____

Company Name (if applicable) _____

Address Line 1 _____

Address Line 2 _____

City _____

Prov./State _____ Postal Code: _____

Phone: _____ Fax: _____ Email: _____

Payment Method

- PayPal E-transfer COD
- Visa MasterCard AMEX

Ship Via

- Canada Post UPS Other (Specify)
- Loomis Pickup _____

Credit card Number _____ Expiry Date _____ CVV code on back _____

Item number	Description	Size	Color	Qty.	Price/ea.	Total

Photocopy this blank form as often as needed TOTAL=
Shipping & Handling, Taxes and COD Charges are extra were applicable.

CUSTOM SERVICES



- Cutting -

We have a variety of machines to cut fabric, felt and material. We will gladly cut any material that you need to have cut to your specifications.

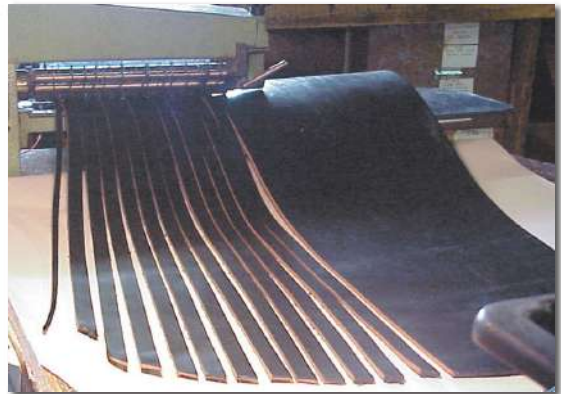

- Strap Cutting -

We can cut-up into strips a wide range of materials to your specifications from 1/4" to 2" widths.



- Clicking -

Send us your dies and we will quickly and professionally do your die cutting with either your own or our material. We also can supply quality custom-made dies. Send in your pattern for a quote.



- Beveling -

This high speed beveler will quickly and professionally edge your leather strapping on all four corners.



- Dying -

We can also edge dye your leather straps or patterns.



- RF Welding - (Radio Frequency)

This is a new method of bonding biothane together. A clean job with no thread to wear off or frustrating sewing on your part.

Index

Absorbine Liniment.....	Page 55	Breast Snaps.....	Page 111-113
Agri Canvas.....	Page 84	Breast Strap Slides.....	Page 114
All Purpose Collar.....	Page 34	Breastcollar Pad.....	Page 36
Aloe Vera Ointment.....	Page 52	Breeching Pad.....	Page 36
Ankle Pads.....	Page 50	Bridle Hooks.....	Page 61
Ankle Straps.....	Page 30	Bridle Leather.....	Page 91-92
Anti Flam.....	Page 54	Bridle Rosettes.....	Page 120
Apron Leather.....	Page 91-92	Brushes.....	Page 57
Awl Blades.....	Page 99	Buckles.....	Page 115
Awl Handles.....	Page 99	Buggy Collars.....	Page 34
		Buggy Jack.....	Page 65
Baby Snaps.....	Page 111-113	Buggy Robe.....	Page 63-64
Back Band Pads.....	Page 85	Buggy Whips.....	Page 60
Back Pads.....	Page 36	Bull Snaps.....	Page 111-113
Bag Balm.....	Page 52	Bull Whips.....	Page 60
Bag Punches.....	Page 96-97	Bun Bags.....	Page 30
Ball Solution.....	Page 55	Burr Out.....	Page 58
Bandage.....	Page 52	Burr Setters.....	Page 96-97
Beery Bits.....	Pages108-110		
Bell Boots.....	Page 50	Calendars.....	Page 72
Bell Drops.....	Page 67-68	Calf Toes.....	Page 47
Bells.....	Page 67-68	Camo Biothane.....	Page 87-89
Belt Buckles.....	Page 70	Cant Hook.....	Page 126
Beta Biothane.....	Page 87-89	Canvas.....	Page 126
Beta Bits.....	Pages108-110	Cattle Halter.....	Page 47
Beta Rope.....	Page 87-89	Chain Twitch.....	Page 59
Billfolds.....	Page 69	Chains.....	Page 114&117
Bimenctrin Paste.....	Page 57	Check Bits.....	Pages108-110
Binder Canvas.....	Page 126	Check Chains.....	Page 117
Bins.....	Page 107	Check Hooks.....	Page 117
Biothane Beltings.....	Page 87-89	Chew Stop.....	Page 59
Biothane Harness.....	Pages 10-28	Chuckwagon Hames.....	Page 38
Biothane Sheeting.....	Page 84	Chuckwagon Harness.....	Page 26
Biothane Straps.....	Page 87-89	Clevis with Bolt.....	Page 124
Bit Guards.....	Pages108-110	Clickers.....	Page 100-101
Bit Snaps.....	Page 111-113	Clinch Block.....	Page 48-49
Bit Straps.....	Page 43	Clips.....	Page 111-113
Biting Harness.....	Page 30	Clocks.....	Page 78
Bits.....	Pages108-110	Cockeyes.....	Page 114
Black`s Mineral.....	Page 53	Cold Shut Snaps.....	Page 111-113
Blanket Pins.....	Page 63-64	Collar Caps.....	Page 85
Blanket Straps.....	Page 85	Collar Hooks.....	Page 61
Blankets.....	Page 63-64	Collar Mirrors.....	Page 78
Blankets.....	Page 63-64	Collar Pads.....	Page 34-35
Blind Cups.....	Pages 82-83	Collars.....	Page 33
Blinds.....	Pages 82-83	Collars Straps.....	Page 85
Blu-Kote.....	Page 52	Combs.....	Page 57-58
Blue Lotion.....	Page 52	Concord Clips.....	Page 114
Body Bells.....	Page 67-68	Controller Bits.....	Pages108-110
Books.....	Pages 73-75	Conways.....	Page 115
Boot Brushes.....	Page 65	Copper Bits.....	Pages108-110
Borg Material.....	Page 84	Copper Rivets.....	Page 121
Borg Pads.....	Page 35-36	Cornucrecine.....	Page 51
Botton Hooks.....	Page 117	Cotton Rope.....	Page 79
Box Loops.....	Pages 82-83	Cow Ties.....	Page 47
Braiding Bench.....	Page 40	Cribbing Straps.....	Page 59
Brasso.....	Page 80-81	Croopers.....	Page 85

Index

Curb Chains	Pages108-110	Flex Wrap	Page 52
Curb Hooks	Pages108-110	Fly Masks.....	Page 56
Curry Combs	Page 57	Fly Nets.....	Page 56
Cut & Heal.....	Page 52	Fly Sheets	Page 63-64
Cutting Board.....	Page 85	Fly Spray.....	Page 56
		Fly Swatter.....	Page 56
Dairy Supplies	Page 47	Fly Tape	Page 56
Decorations.....	Page 29&116-120	Foot Presses	Page 100-101
Dee Rings	Page 115	Footman Loops.....	Page 115
Deer Hair Pads	Page 35	Forecarts	Page 128
Dental Float	Page 51	Forks.....	Page 65
Dewormer.....	Page 57	Four Horse Evener.....	Page 126
Diamond Chains.....	Page 117	Front Shields.....	Page 29
Docks	Page 85		
Dog Collars.....	Page 46	Gag Pieces	Page 115
Dog Leashes	Page 46	Gall Salve	Page 52
Door Hangers.....	Page 67-68	Gloves.....	Page 66
Door Latches.....	Page 61	Glucosamine.....	Page 54
Double Bar Buckles	Page 115	Granite Belting	Page 87-89
Double Driving Harness	Page 22	Granite Harness.....	Pages 10-28
Double End Snaps	Page 111-113	Granite Rope	Page 87-89
Double Trees.....	Page 124	Granite Straps	Page 87-89
Draw Guages.....	Page 94	Grey Apron Splits.....	Page 91-92
Draw Hooks.....	Page 124	Grommets Setter.....	Page 96-97
Driving Bits.....	Pages108-110	Grooming Supplies	Page 57-58
Driving Carts	Page 127	Groovers.....	Page 94
Driving Gloves.....	Page 66		
Driving Harness.....	Pages 22-25	Hair Tassels.....	Page 31
DVDS	Pages 76-77	Halter Snaps	Page 111-113
Dye Box.....	Page 95	Halter Name Plates	Page 116
Dynamint Leg Rub.....	Page 55	Halter Stem	Page 44-45
		Halters.....	Pages 41-43
Easy Entry Carts	Page 127	Hame Balls.....	Page 122
Eberglo Supplement	Page 54	Hame Binders	Page 114
Edge Dye	Page 80-81	Hame Covers	Page 29
Edge Paint	Page 80-81	Hame Parts.....	Page 122
Edge Slickers	Page 104	Hame Ratchets	Page 122
Edge Tools.....	Page 94	Hames	Page 37-38
Eggbutt Bitts	Pages108-110	Hammer	Page 48-49
Eqvalan Gold.....	Page 57	Hammer Straps.....	Page 128
		Hand Creasers	Page 94
Face Drops	Page 29	Hand Needles	Page 99
Fake Fur	Page 84	Hand Scissors.....	Page 107
Farm Hames.....	Page 37-38	Hand Tools	Page 93-96
Farrier Supplies	Page 48-49	Hanging Decorations	Page 118
Farrier`s Formula	Page 55	Happy Mouth Bits.....	Pages108-110
Feather Plumes.....	Page 31	Harness.....	Pages 10-28
Feed Bags.....	Page 62	Harness Decorations	Page 29&116-120
Feed Carts.....	Page 59	Harness Hooks.....	Page 61
Feed Scoops	Page 59	Harness Leather	Page 91-92
Feeders	Page 62	Harness Oils.....	Page 80-81
Felt Insoles	Page 65	Harness Stands	Page 61
Felt Material	Page 84	Harrowing Carts	Page 128
Felt Pads.....	Page 35	Hay Bags	Page 62
Fetlock Shears.....	Page 58	Hay Feeders.....	Page 62
Field Collars.....	Pages 33-34	Head Halter	Page 43
Flat Chains.....	Page 117	Healthy Horse.....	Page 54

Index

Heel Chains	Page 114	Leather Splitters	Page 100-101
Herbal Solution	Page 52	Leather Stains.....	Page 80-81
Hitch Pins	Page 128	Leg&Muscle Rub.....	Page 55
Hitching Posts	Page 78	Letters	Page 116
Hitching Rings	Page 61	Line Drops	Page 31
Hock Boots.....	Page 50	Liniment	Page 55
Hole Punches	Page 96-97	Little Wonder Attachments.....	Pages 102-103
Hoof Boots.....	Page 50	Little Wonder Press.....	Page 100-101
Hoof Brush.....	Page 58	Liverpool Bits.....	Pages108-110
Hoof Builder.....	Page 51	Lockjaw Snaps	Page 111-113
Hoof Dressing.....	Page 51	Logging Hook.....	Page 126
Hoof Heal.....	Page 51	Logging Supplies.....	Page 66
Hoof Knife.....	Page 48-49	Logging Tongs.....	Page 126
Hoof Nipper	Page 48-49	Loop Irons.....	Page 95
Hoof Pick.....	Page 48-49	Lunge Lines.....	Page 44-45
Hooflex.....	Page 50		
Hook and Loop.....	Page 85	Magnetic Tool Bar	Page 95
Horse Shoe Puzzles	Page 69	Mailboxes	Page 65
Horse Shoes	Page 48-49	Mallets.....	Page 96-97
Horsemans One Step	Page 80-81	Mane Flowers.....	Page 40
Hot Cutters	Page 100-101	Mane Rolls.....	Page 40
Hot Knife.....	Page 95	Manure Bags	Page 30
Humane Twitch.....	Page 59	Marathon Harness.....	Page 27
		Martingale Drops	Page 29
Insoles.....	Page 65	Measuring Stick.....	Page 59
Iodine Spray	Page 52	Military Bits	Pages108-110
Ivermectin Paste	Page 57	Milk Jug Trap	Page 56
		Mineral	Page 53
J.I.C Bits.....	Pages108-110	Mini Carts	Page 127
Jack Snaps.....	Page 111-113	Mirrors	Page 78
Jaw Breaker Bits.....	Pages108-110	Mitts	Page 66
Jiffy Rivets.....	Page 123	Mouth Speculum.....	Page 51
Jockey Irons	Page 125	Mule Bits	Pages108-110
		Muzzles	Page 59
Kidney Drops.....	Page 29		
Kidney Flush.....	Page 54	Nail Clincher	Page 48-49
Knee Pads	Page 50	Nails.....	Page 48-49
Knives.....	Page 93	Name Plates	Page 65&116
Kopper Kare	Page 51	Neatsfoot Oils.....	Page 80-81
		Neatslene Oils	Page 80-81
Ladderloc Buckles	Page 109	Neck Pads	Page 34
Lap Blankets.....	Page 63-64	Neck Rope	Page 44-45
Latches.....	Page 61	Neck Ties	Page 44-45
Latigo Leather	Page 91-92	Neckyokes	Page 125
Lead Ropes.....	Page 44-45	Needles	Page 99
Lead Shanks	Page 44-45	Neoprene	Page 84
Leather.....	Page 91-92	Neoprene Pads	Page 35-36
Leather Belts.....	Page 70	No Thrush.....	Page 51
Leather Cleaners.....	Page 80-81	Nose Covers.....	Page 47
Leather Dressings.....	Page 80-81	Nose Plates.....	Page 116
Leather Dye.....	Page 80-81	Nutra-Glo Supplement	Page 54
Leather Finish	Page 80-81	Nylin Webbing.....	Page 90
Leather Harness.....	Pages 10-25	Nylon Harness	Pages 10-28
Leather New	Page 80-81	Nylon Rings.....	Page 123
Leather Punches	Page 93	Nylon Sewing Thread	Page 99
Leather Skivers.....	Page 93		
Leather Spats	Page 50	Oiling Bottles	Page 107

Index

Oils	Page 80-81	Riding Bridles.....	Page 42
One Man Twitch	Page 59	Rings	Page 115
Organizers.....	Page 107	Rivet Setters	Page 96-97
Ornaments.....	Page 29&116-120	Rivets.....	Page 121
Overstitch Wheels.....	Page 94	Robes.....	Page 63-64
		Roller Buckles	Page 115
Pad Bridges	Page 115	Rope	Page 79
Pad Screw Pliers.....	Page 94	Rope and Pulley Tandom Hitch	Page 126
Pads Screws	Page 117	Rope Clamps.....	Page 79
Panic Snaps	Page 111-113	Rope Thimble	Page 79
Parade Harness.....	Pages 10-13	Rosettes.....	Page 120
Parasite Formula.....	Page 54	Rotary Punches	Page 104
Patent Leather	Page 91-92	Round Knives.....	Page 93
Patina Material	Page 84	Rubber Bits.....	Pages108-110
Patio Seats	Page 128	Rubber Loops	Page 123
Patterns	Pages 82-83	Rubber Sheeting.....	Page 84
Pearson Parts.....	Page 105-106	Rump Bells.....	Page 67-68
Pearson Sewing Machine.....	Page 105-106	Russet Leather.....	Page 91-92
Pee Wee Bits.....	Pages108-110		
Pens Stands.....	Page 70	Saddle Skirting.....	Page 91-92
Pet Supplies	Page 46	Saddle Soap.....	Page 80-81
Pinetar	Page 51	Safety Snaps	Page 111-113
Pioneer Cart.....	Page 128	Scissor Snaps	Page 111-113
Pioneer Equipment.....	Page 128	Scoops	Page 59
Plastic Hardware.....	Page 109	Self Centering Punches.....	Page 104
Plastic Loops	Page 123	Self Centering Table	Page 96-97
Plastic Rings	Page 123	Sew Tuff Material.....	Page 85
Plastic Rods.....	Page 85	Sew-on Traces	Pages 82-83
Plumes	Page 31	Sewing Awls.....	Page 99
Pointed Rivets.....	Page 117	Sewing Machine Lights.....	Page 107
Polishes	Page 80-81	Sewing Machine Oils	Page 107
Poly Rope.....	Page 79	Sewing Thread.....	Page 99
Polyester Felt.....	Page 84	Shackle Snaps.....	Page 111-113
Pony Carts.....	Page 127	Shampoo	Page 58
Poultice Boots.....	Page 50	Sheeting	Page 84
Proud Flesh Dust.....	Page 52	Shipping Boots.....	Page 50
Puller Bits.....	Pages108-110	Shoe Pad.....	Page 48-49
Pulling Collars	Page 33	Shoe Puller	Page 48-49
Pulling Connectors.....	Page 114	Shoeing Stock.....	Page 48-49
Pulling Harness	Pages 10-13	Show Halters	Page 39&47
Pulling Hames	Page 37	Show Sticks.....	Page 40
Punch Machines.....	Page 98-101	Showsheen	Page 58
Punch Tubes.....	Page 93	Side Release Buckles	Page 109
PVC Sheeting.....	Page 84	Signs	Page 71
		Silvo.....	Page 80-81
Quest Dewormer	Page 57	Simpson Bits.....	Pages108-110
Quick Links.....	Page 111-113	Single Driving Harness.....	Page 24
		Single Tree Hooks.....	Page 124
Rain Rugs	Page 63-64	Single Trees	Page 124
Rasp	Page 48&51	Single Work Harness	Page 20
Reflective Biothane	Page 87-89	Sled Runners.....	Page 127
Regulator Bits.....	Pages108-110	Sleigh Runner	Page 127
Rein Rounders.....	Page 94	Slickers	Page 104
Repair Buckles.....	Page 115	Slide Loops	Page 123
Repair Snaps	Page 111-113	Slot Punches.....	Page 96-97
Respi-Free	Page 54	SMZ Signs	Page 65
		Snaffle Bits.....	Pages108-110

Index

Snap Fasteners Dies	Page 96-97	Tooth Rasp	Page 51
Snaps.....	Page 111-113	Toy Horses.....	Page 70
Sole Leather	Page 91-92	Trace Dees.....	Page 114
Spats	Page 50	Trace Rings	Page 114
Speedy Stitchers	Page 99	Trace Squares.....	Page 114
Spot Setters	Page 96-97	Traces	Page 28
Spots	Page 121	Training Harness.....	Page 30
Spreader Bars.....	Page 125	Tubular Rivets.....	Page 121
Spreaders	Page 31	Tugs	Page 28
Spring Snaps.....	Page 111-113	Turnout Blankets	Page 63-64
Standard Beta	Page 87-89	Turpentine.....	Page 51
Staples	Page 121	Tuttle's Liniment	Page 55
Stitching Horses	Page 94	Twisted Clevis.....	Page 128
Straight Bits.....	Pages108-110	Twitch.....	Page 59
Strap Cutters.....	Page 100-101	Two Grooved Biothane	Page 87-89
Strap End Punches	Page 96-97		
Strop Board	Page 95	Umbrellas	Page 65
Stud Bits.....	Pages108-110	Urethane Loops	Page 123
Studs for Shoes	Page 48-49		
Super Heavy Beta.....	Page 87-89	Velcro	Page 85
Supershine	Page 50	Vests.....	Page 66
Surcingle Buckles	Page 115	Vice Grip Pouch	Page 66
Sweat Pads.....	Pages 34-36	Vinyl Pads	Page 35
Sweat Pads Clips	Page 115		
Sweat Scraper	Page 58	Waist Belts	Page 70
Swivel Snaps	Page 111-113	Wall Clocks	Page 78
Swivels	Page 115	Wallets	Page 69
Swivels Chains.....	Page 117	Water Bowls.....	Page 59
Synthetic Collars	Pages 33-34	Weather vanes	Page 69
		Weather Stripping	Page 65
Tack Hooks.....	Page 61	Web slides	Page 115
Tack Pullers	Page 96-97	Whip Holders.....	Page 60
Tackle Snaps.....	Page 111-113	Whips	Page 60
Tacks	Page 121	White Leather	Page 91-92
Tail Bows.....	Page 40	Wide mouths.....	Page 109
Tail Drops.....	Page 29	Wind Aid.....	Page 55
Tail Needle	Page 40	Wing Nuts.....	Page 117
Tail Sprigs.....	Page 40	Winkers	Pages 82-83
Tandom Hitch	Page 126	Winkers Stays.....	Pages 82-83
Tapered Loop Irons.....	Page 95	Winter zone Material	Page 84
Tassels.....	Page 31	Wire Bits.....	Pages108-110
Team Bits	Pages108-110	Wonder Dust	Page 52
Terrets	Page 117	Wooden Hames.....	Page 37
Thermal Handle	Page 95	Wooden Horse Rockers.....	Page 70
Thermometers	Page 69	Work Harness.....	Pages 14-21
Thinning Knife	Page 58	Wormer	Page 57
Thistles.....	Page 116	Wound Spray	Page 52
Thread.....	Page 99	Wrap.....	Page 52
Thread Burners	Page 107		
Thread Nippers	Page 107	Yoders Horse Powder	Page 55
Three Horse Evener	Page 126		
Thrush Buster.....	Page 51	ZEV Liquid	Page 55
Tie Straps	Page 44-45		
Toggles.....	Page 116		
Tongue Caps	Page 128		
Tool Bar.....	Page 95		
Tool Belt.....	Page 66		